



State of Kuwait
Ministry of Education



Modified FUN WITH English

Handwriting Book



 LONGMAN

Grade

3



State of Kuwait
Ministry of Education



Modified
FUN WITH
English

Handwriting Book



Grade

3

© Ministry of Education - State of Kuwait, 2017
All rights reserved; no part of this publication
may be reproduced, stored in a retrieval system,
or transmitted in any form or by any means, electronic,
mechanical, photocopying, recording, or otherwise,
without the prior written permission of the Publishers.

Egyptian International Publishing Company - Longman,
10a Hussein Wassef Street,
Messaha Square,
Dokki,
Cairo,
Arab Republic of Egypt

The Longman imprint is the property of Pearson Education
being used under license from Pearson Education.

First edition 2004
Second edition 2006
Third edition 2009
Fourth edition 2017,2019
Fifth edition 2020, 2021
Sixth edition 2021, 2022, 2022/2023

Printed in Kuwait by :
Al-Alfain Printing, Publication & Distribution Co. K.S.C.C.



PDF Book

The Ministry of Education wishes to thank the Evaluation
Committee of Kuwait Ministry of Education:

Professor Najat Al Mutawa, Kuwait University;
Professor M. Rifqy Eassa, Educational Holding Group;
Dr. Yusr Al-Madani, Kuwait University;
Dr. Badria A. Al-Haji, College of Basic Education (PAAET);
Mrs. Sakina A. Hussain, Senior Supervisor, MoE;
Mr. Mohamed Naguib Ali, ELT Supervisor, MoE;
Mr. Sayed Ghareeb Abdel Rahman, Supervisor, MoE;
Mr. Alhu Hamu Sharaha, Senior Teacher, MoE;
Mrs. Khawla Al Refae, Senior Teacher, MoE;
Ms. Aisha Al-Awadhi, Assistant Principal, MoE.

The Ministry of Education wishes to thank the Amendments
Committee of Kuwait Ministry of Education:

Mrs. Nouria Al Sedra, ELT Senior Supervisor, MoE;
Mr. Mohamed Nagib Ali, ELT Supervisor, MoE;
Mr. Sayed Ghareeb AbdelRahman, ELT Supervisor, MoE;
Mr. Mahmoud Hammouda, ELT Supervisor, MoE;
Mrs. Khawla Al Refae, ELT Supervisor, MoE;
Mr. Mohamed Sallam, ELT Supervisor, MoE;
Mrs. Sherifah Al Sayegh, ELT Head of Department, MoE;
Mrs. Rehab Mohamed Nadim, ELT Head of Department, MoE;
Mrs. Rehab Mohamed Hasabullah, ELT Head of Department, MoE;
Mrs. Hessa Al-Banwan, ELT Head of Department, MoE;
Mrs. Noura Al-Mokmash Al-Azmi, ELT Head of Department, MoE;
Mrs. Azza Mohammad Awad, ELT Head of Department, MoE;
Mrs. Nevine Abdul Majeed Omar, ELT Head of Department, MoE.

The Ministry of Education wishes to thank the Amendments
Committee of Kuwait Ministry of Education (2017):

Mrs. Hadeel Hassan Al Kandari, ELT Senior Supervisor, MOE;
Mrs. Abeer AL-Jeeran, ELT Supervisor, MOE ;
Mrs. Germeen Gendia, ELT Supervisor, MOE;
Mrs. Rehab Mohamed Nadim, ELT Supervisor, MOE;
Ms. Sakeena Kankouni, ELT HOD, MOE;
Mrs. Mariam Mendakar, ELT HOD, MOE;
Ms. Joza M. Al-Otaibi, HOD, Curricula Development Departemnet



Share on evaluation



حضرة صاحب السمو الشيخ نواف الأحمد الجابر الصباح
أمير دولة الكويت

H.H. Sheikh Nawaf AL-Ahmad Al-Jaber Al-Sabah
The Amir Of The State Of Kuwait





سمو الشيخ مشعل الأحمد الجابر الصباح
ولي عهد دولة الكويت

H.H. Sheikh Meshal AL-Ahmad Al-Jaber Al-Sabah
The Crown Prince Of The State Of Kuwait



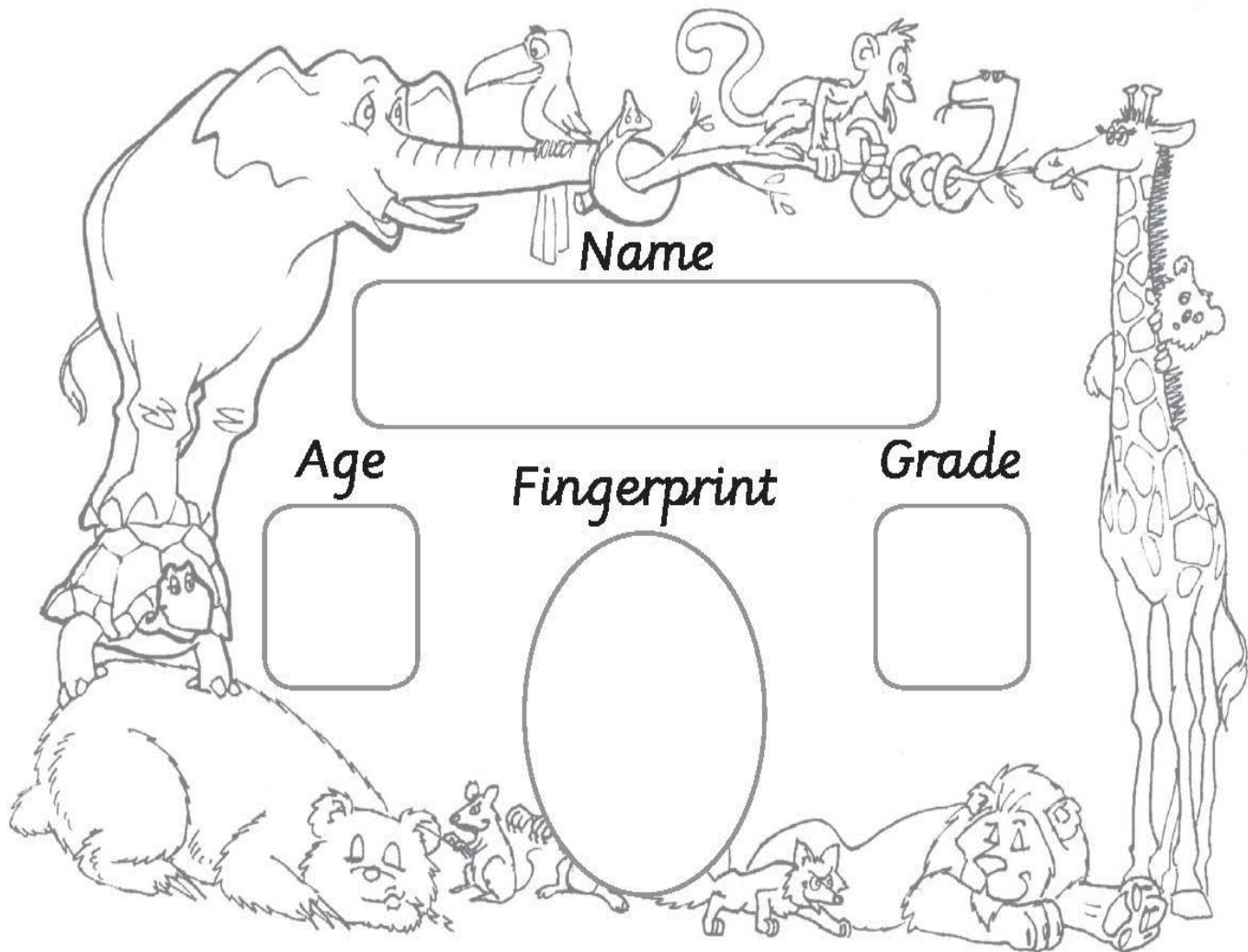

Name

Age

Fingerprint

Grade

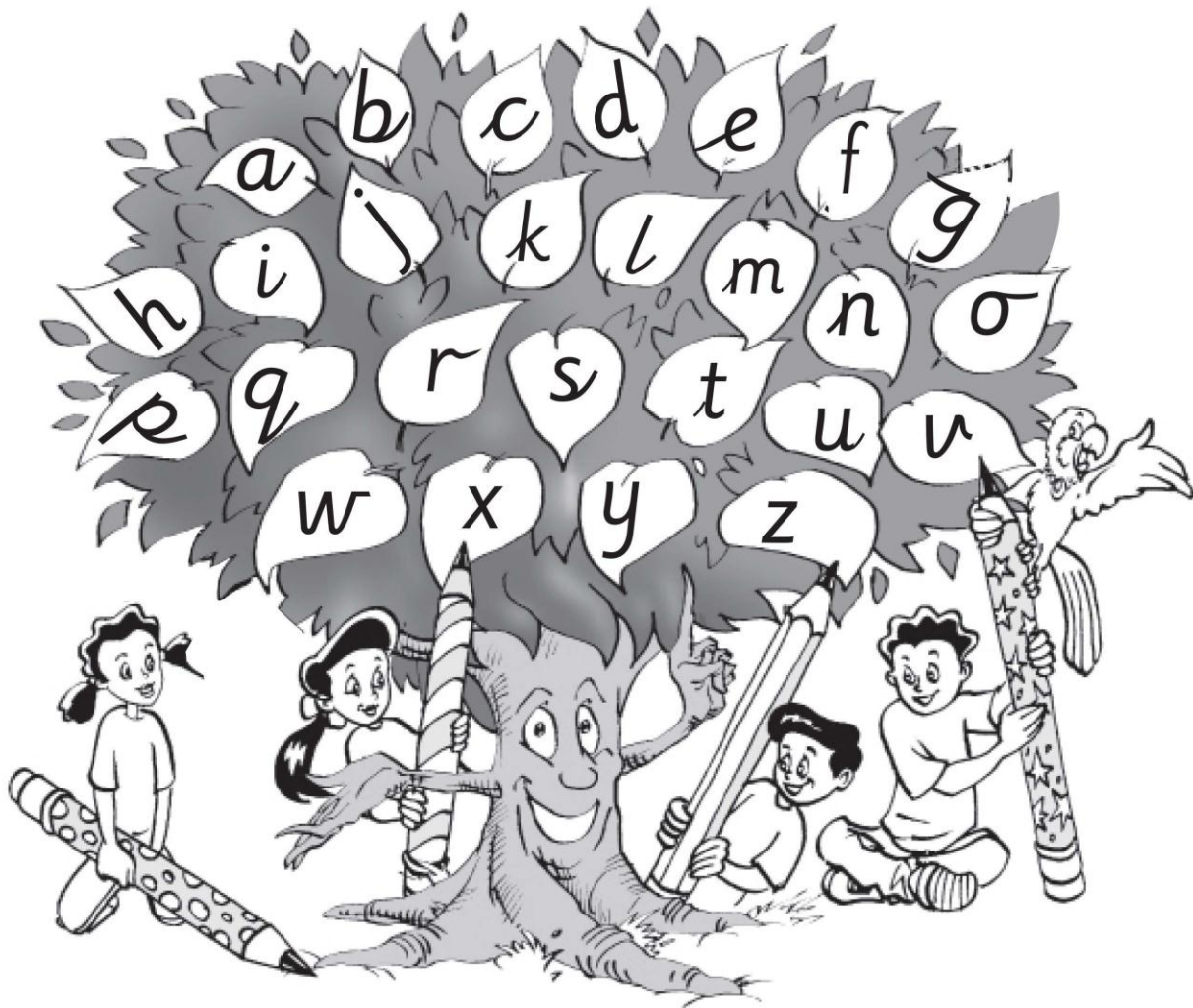

Trace and copy

a e m r u w

Blank handwriting practice line with a solid top line, a dashed middle line, and a solid bottom line.

Blank handwriting practice line with a solid top line, a dashed middle line, and a solid bottom line.



b d h k l

Blank handwriting practice line with a solid top line, a dashed middle line, and a solid bottom line.

Blank handwriting practice line with a solid top line, a dashed middle line, and a solid bottom line.

Trace and copy

p g q y

Blank handwriting practice line with a dashed midline.

Blank handwriting practice line with a dashed midline.



i j l t f

Blank handwriting practice line with a dashed midline.

Blank handwriting practice line with a dashed midline.



Trace and copy

A B C D E F

Blank handwriting practice line



G H I J K L M N O P

Blank handwriting practice line

Q R S T U V W X Y Z

Blank handwriting practice line



Trace and copy

mosque mosque mosque

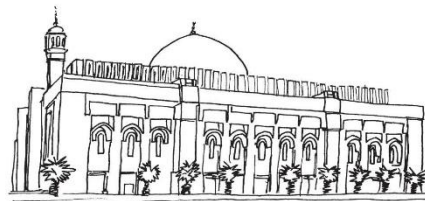

shops shops shops shops

tower tower tower tower



Trace and copy

photo

photo

photo

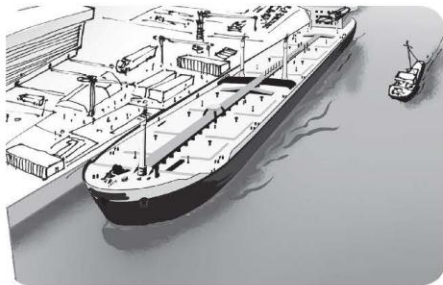
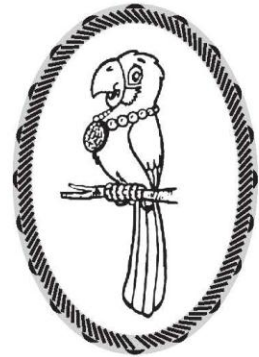

harbour

harbour

harbour

sea

sea

sea

sea

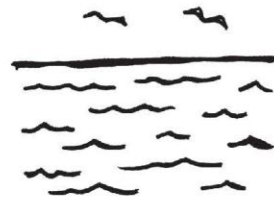

Trace and copy

email

email

email



parrot

parrot

parrot

beach

beach

beach

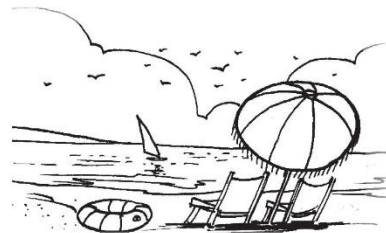

Trace and copy

grandmother grandmother



breakfast breakfast

get up get up get up



Trace and copy

sunrise sunrise sunrise

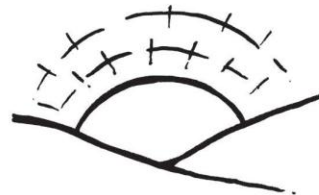

sunset sunset sunset

dinner dinner dinner



Trace and copy

ZOO ZOO ZOO ZOO

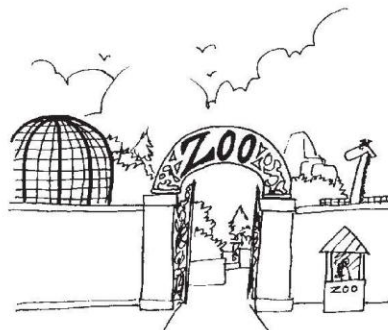

work work work

tomorrow tomorrow

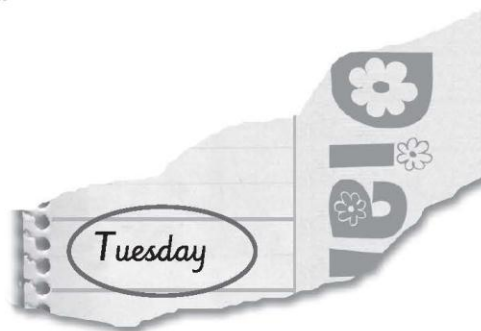

Trace and copy

I'm painting. *I'm painting.*

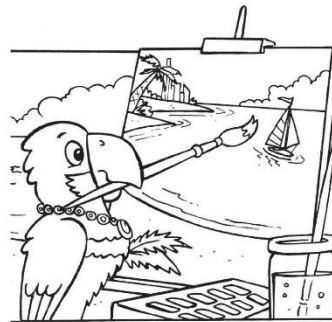

I collect stamps.

I collect stamps.



Trace and copy

I like collecting shells. *I like collecting shells.*

Two sets of horizontal dashed lines for tracing and copying practice.



I like sailing. *I like sailing.*

Two sets of horizontal dashed lines for tracing and copying practice.



Trace and copy

Salma has thirty dolls. Salma has thirty dolls.

Two sets of blank handwriting lines for tracing and copying the sentence "Salma has thirty dolls."



My hobby is playing football.

My hobby is playing football.

Blank handwriting lines for tracing and copying the sentence "My hobby is playing football."



Trace and copy

The firemen were brave. The firemen were brave.



There was a fire. There was a fire.



Trace and copy

A baker works in a bakery.

A baker works in a bakery.



I want to be a zookeeper.

I want to be a zookeeper.



Trace and copy

I want to be a doctor. I want to be a doctor.

Two sets of blank handwriting lines for copying the sentence "I want to be a doctor."



I want to be an artist. I want to be an artist.

Two sets of blank handwriting lines for copying the sentence "I want to be an artist."



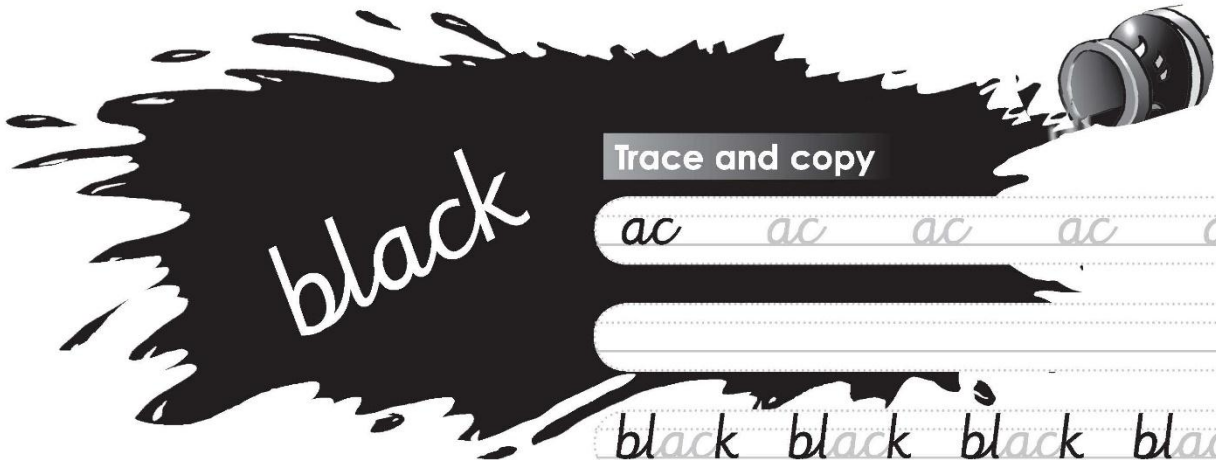

Trace and copy

ac ac ac ac ac

black black black black

ea ea ea ea ea

eat eat eat eat eat



Trace and copy

an an an an an

man man man man

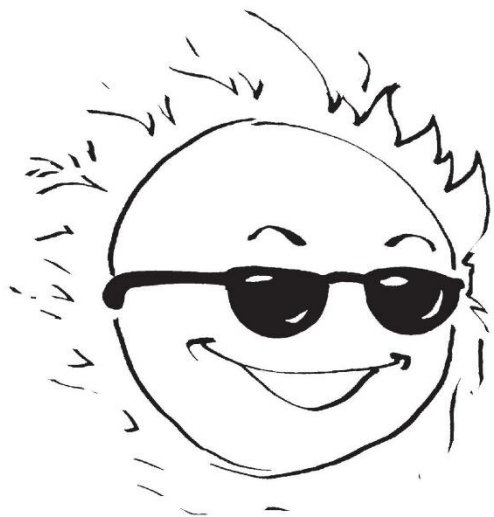

un un un un un

sun sun sun sun sun

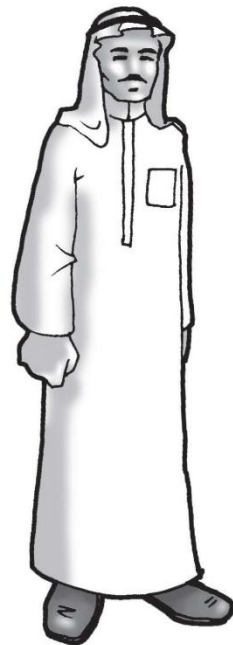

Trace and copy

um um um um um

mum mum mum mum

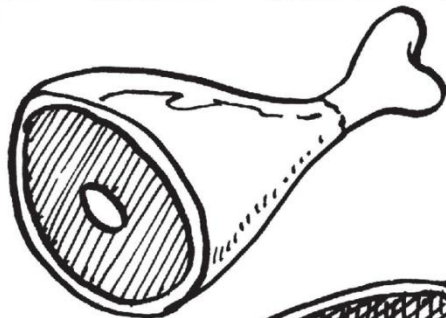

me me me me me

meat meat meat meat



Trace and copy

ou ou ou ou ou

mouth mouth mouth

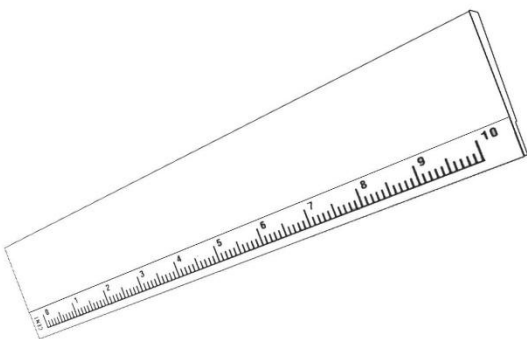
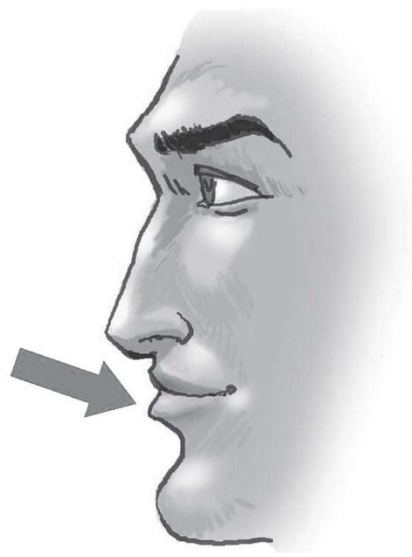

ru ru ru ru ru

ruler ruler ruler ruler



Trace and copy

re re re re re

dress dress dress dress

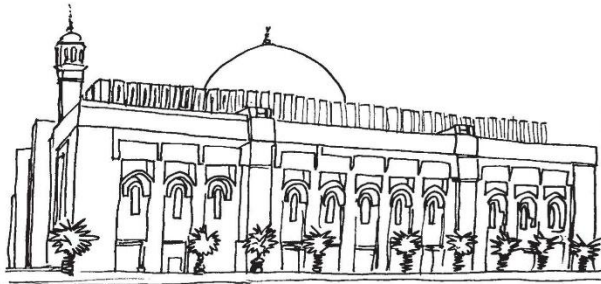

os os os os os

mosque mosque mosque



Trace and copy

wa wa wa wa wa

Kuwait Kuwait Kuwait

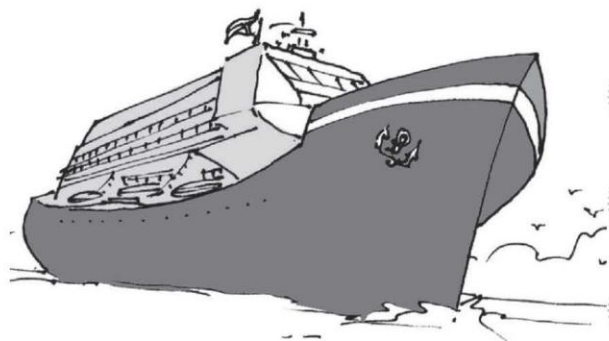
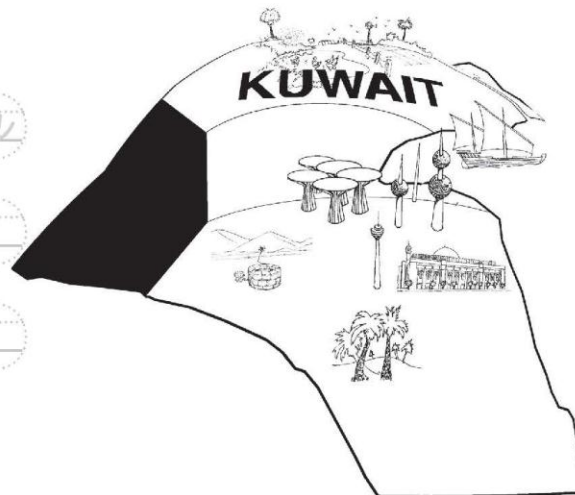

oa oa oa oa oa

boat boat boat boat



Trace and copy

ch ch ch ch ch

chair chair chair chair

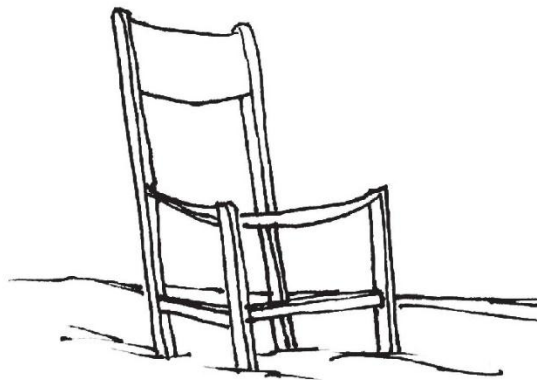

al al al al al

falcon falcon falcon



Trace and copy

ab ab ab ab ab

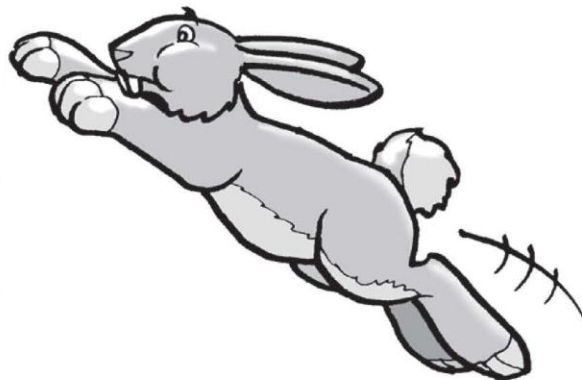

rabbit rabbit rabbit

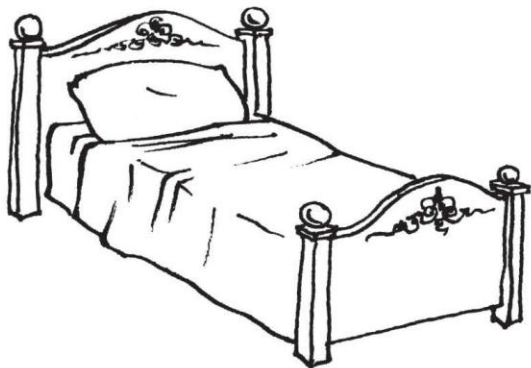

ed ed ed ed ed

bed bed bed bed bed



Trace and copy

he he he he he

hen hen hen hen hen

da da da da da

dad dad dad dad



Trace and copy

lu lu lu lu lu

lunch lunch lunch lunch



be be be be be

beach beach beach beach



Trace and copy

la la la la la

Blank handwriting practice lines for the word 'la'.

class class class class



ke ke ke ke ke

Blank handwriting practice lines for the word 'ke'.

bike bike bike bike bike



Trace and copy

rb rb rb rb rb

harbour harbour harbour

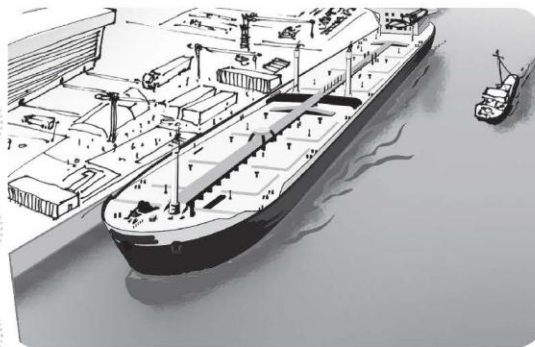

ol ol ol ol ol

doll doll doll doll



Trace and copy

ig ig ig ig ig

Blank handwriting practice lines for the word 'ig'.

big big big big big

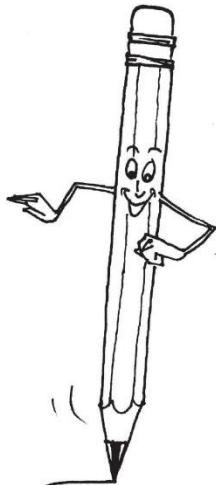

pe pe pe pe pe

Blank handwriting practice lines for the word 'pe'.

pencil pencil pencil pencil



Trace and copy

op op op op op

shop shop shop shop



ry ry ry ry ry

library library library



Trace and copy

fe fe fe fe fe

giraffe giraffe giraffe

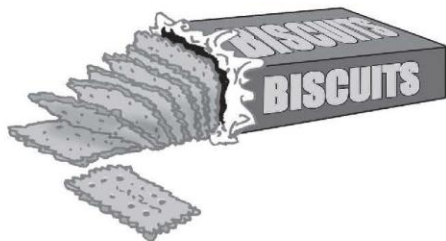
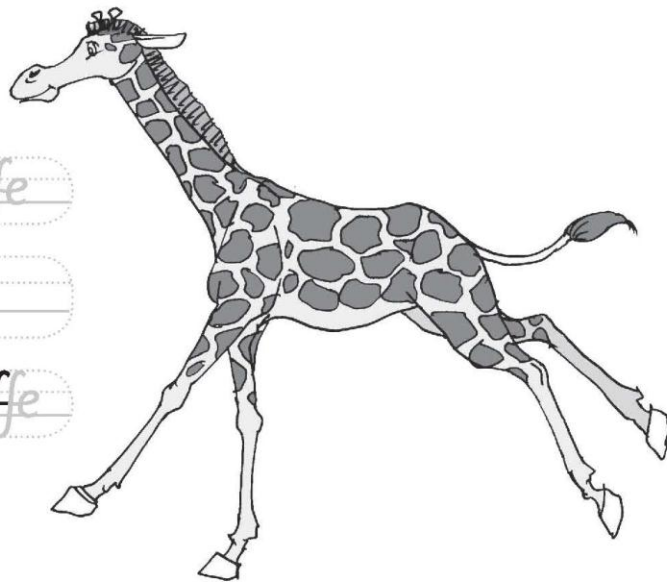

ts ts ts ts ts

biscuits biscuits biscuits



Trace and copy



desert desert desert

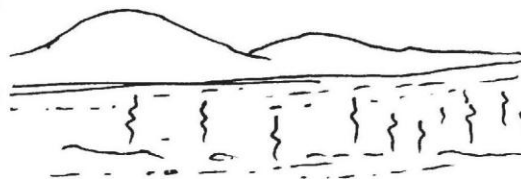

stars stars stars stars

plants plants plants



Trace and copy

sunny sunny sunny sunny

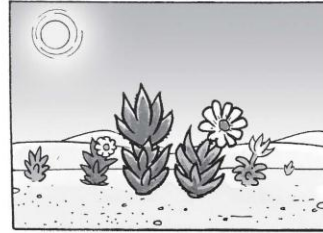

windy windy windy

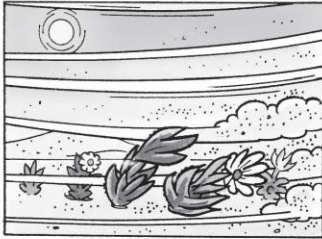

rainy rainy rainy

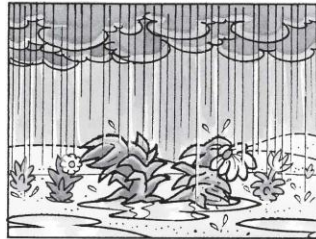

Trace and copy

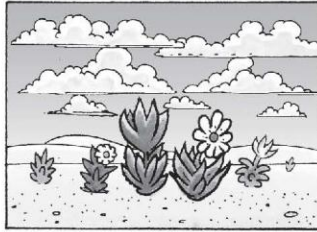

cloudy cloudy cloudy

weekend weekend weekend



night night night night



Trace and copy

doctor doctor doctor doctor



stomach stomach stomach

medicine medicine medicine



Trace and copy

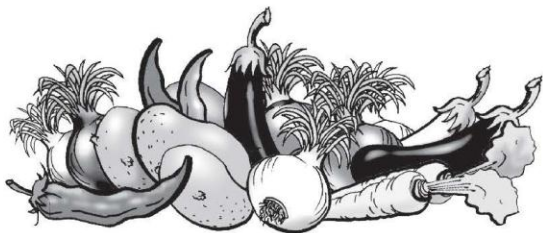

vegetables vegetables vegetables

Blank handwriting practice lines for the word 'vegetables'.

fish fish fish fish

Blank handwriting practice lines for the word 'fish'.

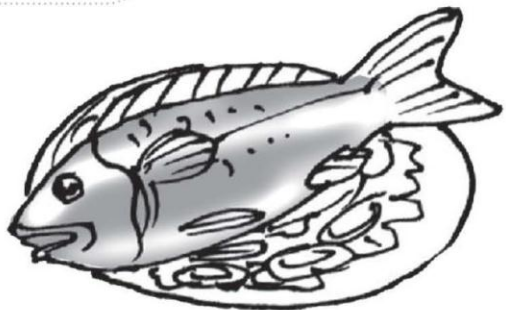

fruit fruit fruit fruit fruit

Blank handwriting practice lines for the word 'fruit'.



Trace and copy



knife knife knife knife

Blank handwriting practice lines for the word 'knife'.

spoon spoon spoon spoon

Blank handwriting practice lines for the word 'spoon'.

fork fork fork fork

Blank handwriting practice lines for the word 'fork'.

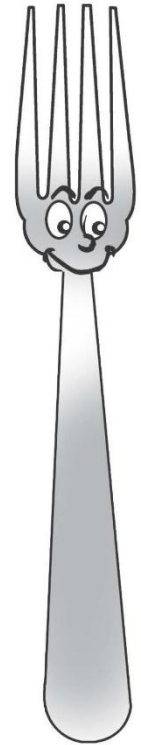
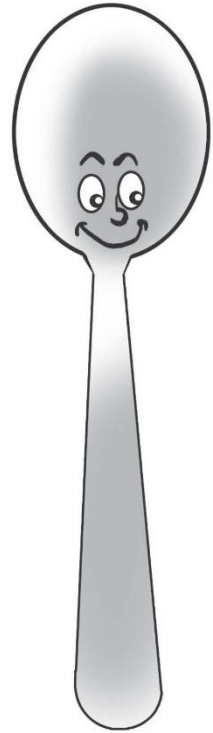

Notes

