

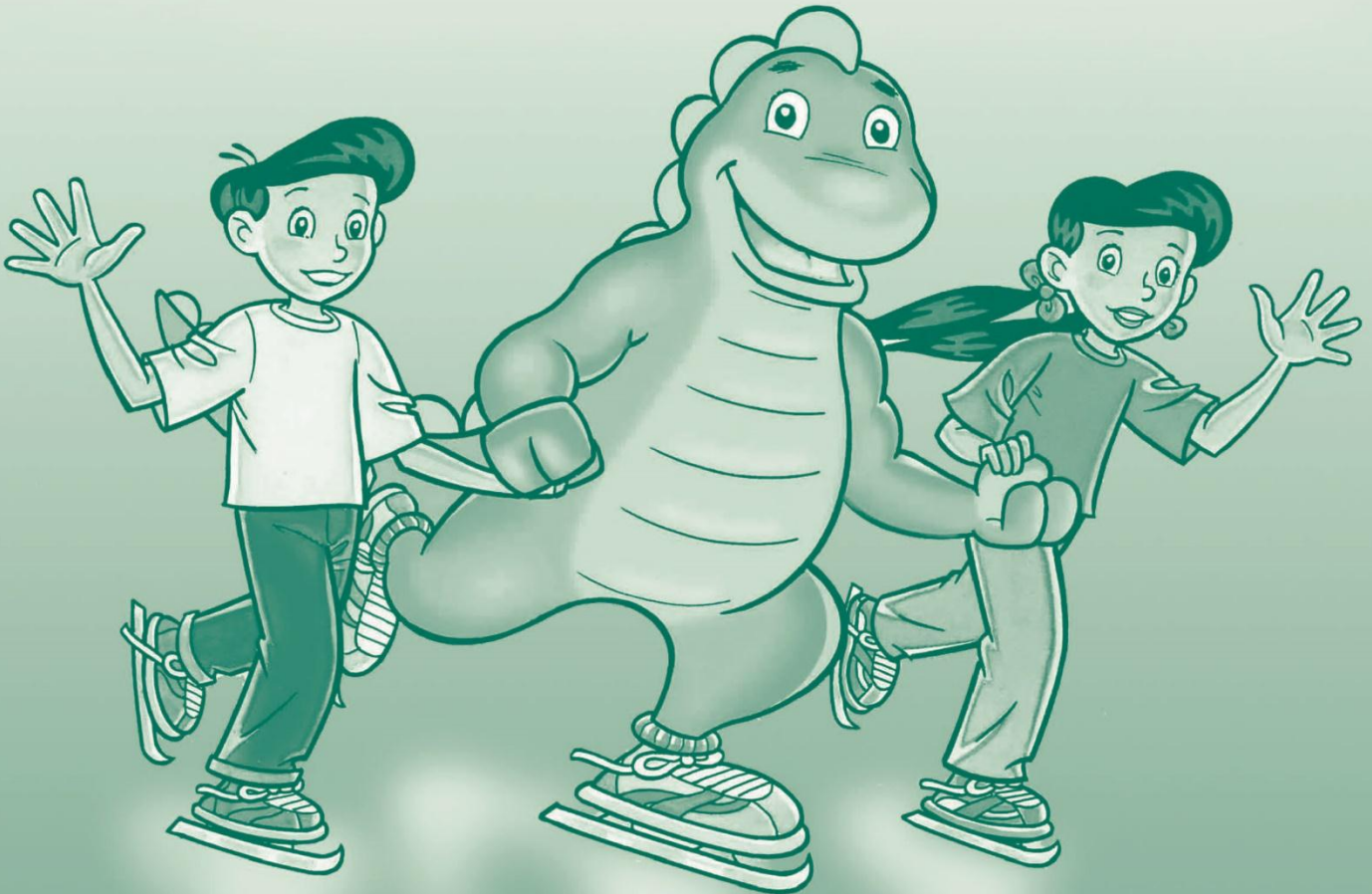

State of Kuwait
Ministry of Education

NEW

FUN WITH English



Activity Book

Grade

2A

 **LONGMAN**

Julia Allen • Margaret Iggulden



State of Kuwait
Ministry of Education



NEW FUN WITH **English**

Activity Book Grade 2A

Julia Allen • Margaret Iggulden

 **LONGMAN**

© Ministry of Education - State of Kuwait, 2009

All rights reserved; no part of this publication may be reproduced, stored in a retrieval system, or transmitted in any form or by any means, electronic, mechanical, photocopying, recording, or otherwise, without the prior written permission of the Publishers.

Egyptian International Publishing Company - Longman,

10a Hussein Wassef Street,
Messaha Square,
Dokki,
Cairo,
Arab Republic of Egypt

The Longman imprint is the property of Pearson Education being used under license from Pearson Education.

First printed in 2003

Reprinted in 2004, 2005, 2006, 2009

Second edition 2020 - 2021 / 2021 - 2022 / 2022 - 2023

ISBN: 977 - 16 - 1210 - 7

Deposit No.: 14339 / 2009

Printed in Kuwait by: Printed in Kuwait by : Dar Al- Qabas Press. Printing and Publishing..

Acknowledgements:

Additional material provided by Matthew Hancock

The publisher wishes to thank the Evaluation Committee of Kuwait Ministry of Education:

Professor Najat Al-Mutawa, Kuwait University;
Professor M. Rifqy Eassa, Educational Holding Group;
Dr. Yusur Al-Madani, Kuwait University;
Mrs. Noha Abdulrazzak Alateegi, College of Basic Education (PAAET);
Mrs. Sakina A. Hussein, Senior Supervisor, MoE;
Mr. Mohamed Nagib Ali, ELT Supervisor, MoE;
Mr. Sayed Ghareeb Abdel Rahman, Supervisor, MoE;
Mr. Alhu Hamu Sharaha, Senior Teacher, MoE;
Mrs. Khawla Al-Refaee, Senior Teacher, MoE;
Mr. Mohamed Ibrahim Azatour, Teacher, MoE;
Ms. Aisha Al-Awadhi, Assistant Principal, MoE.

The publisher also wishes to thank the Amendments Committee of Kuwait Ministry of Education:

Mrs. Sakina A. Hussein, ELT Supervisor General, MoE;
Mrs. Nouria Al Sedra, ELT Senior Supervisor, MoE;
Mr. Mohamed Nagib Ali, ELT Supervisor, MoE;
Mr. Sayed Ghareeb AbdelRahman, ELT Supervisor, MoE;
Mr. Mahmoud Hammouda, ELT Supervisor, MoE;
Mrs. Khawla Al Refaee, ELT Supervisor, MoE;
Mr. Mohamed Sallam, ELT Supervisor, MoE;
Mrs. Sherifah Al Sayegh, ELT Head of Department, MoE;
Mrs. Rehab Mohamed Nadim, ELT Head of Department, MoE;
Mrs. Hessa Al-Banwan, ELT Head of Department, MoE;
Mrs. Noura Al-Mokmash Al-Azmi, ELT Head of Department, MoE;
Mrs. Hana Nasser Al-Hamad, ELT Head of Department, MoE;
Mrs. Azza Mohammad Awad, ELT Head of Department, MoE;
Mrs. Nevine Abdul Majeed Omar, ELT Head of Department, MoE.



PDF Book



Share on evaluation



حضرة صاحب السمو الشيخ نواف الأحمد الجابر الصباح
أمير دولة الكويت

**H.H. Sheikh Nawaf AL-Ahmad Al-Jaber Al-Sabah
The Amir Of The State Of Kuwait**



سمو الشيخ مشعل الأحمد الجابر الصباح
ولي عهد دولة الكويت

H.H. Sheikh Meshal AL-Ahmad Al-Jaber Al-Sabah
The Crown Prince Of The State Of Kuwait

Name

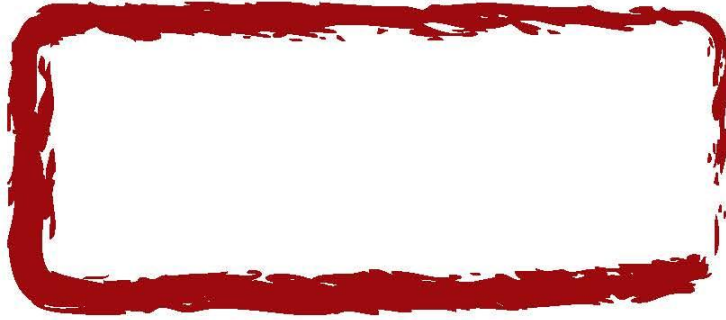
A large, hand-drawn rectangular box with a thick red border, intended for writing a name.

Age

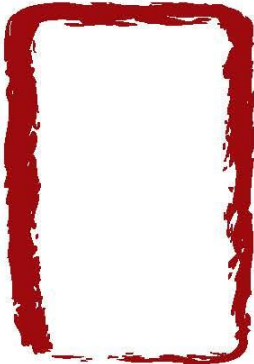
A hand-drawn rectangular box with a thick red border, intended for writing an age.

Grade

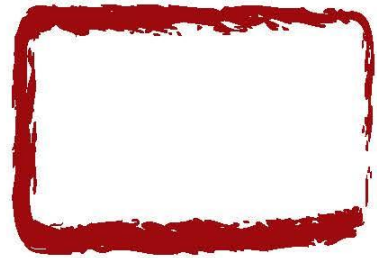
A hand-drawn rectangular box with a thick red border, intended for writing a grade.

Fingerprint

A hand-drawn oval box with a thick red border, intended for a fingerprint.



Contents

Unit 1

My Day

1	Read and write		
2	Order and colour	Read and match	
3	Read and match	Trace and copy	Listen and number
4	Read and match	Trace and copy	Read and match
5	Read and match		

Unit 2

My House

6	Read and match	Trace and copy	Listen and number
7	Read and write	Read, then complete	
8	circle the odd one out	Trace and copy	
9	Look and write	Read and write	

Unit 3

Let's Find It

10	Read and match	Trace and match	Listen and tick
11	Trace and copy	Tick the odd one out	
12	Read, then complete	Write, colour, then talk about the picture	
13	Trace, copy and match	Read and match	Read and match
14	Listen and colour	Count and write	Read, then complete



Contents

Unit 4 Let's have Fun	15	Read and match	Trace, copy and match	Read and complete
	16	Read and match	Read and copy	Listen and number
	17	Read, complete then match	Trace, copy and match	Read and colour
	18	Trace, copy and match	Read and write	
	19	Read and match	Listen and write	Look, Read and write
<hr/>				
Unit 5 At the Restaurant	20	Read, Complete and match	Trace, copy and tick	Order the sentence
	21	Order the numbers, then read	Read and classfiy the words	Read and copy
	22	Read and match	Write	Listen and tick
	23	Tick odd one out	Read and match	Read and complete
	24	Find and match		Read and complete



Date: _____

UNIT

1

My Day



1 Read and write

a

b

d

f

g

i

j

m

o

p

r

t

u

x

Date: _____

UNIT

1



2 Order and colour

a)

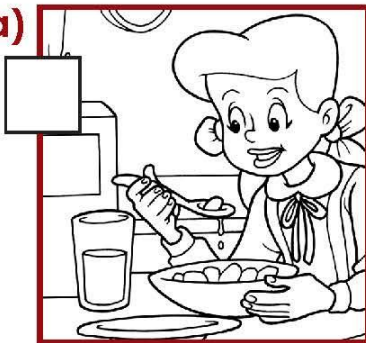

b)



c)



3 Read and match

It's six o'clock.

It's ten o'clock.

a)

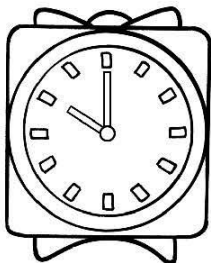

b)

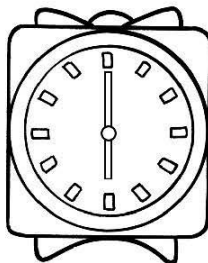

c)

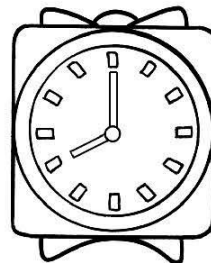



4 Read and match



ay



pray
play
Monday

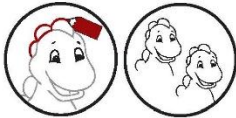
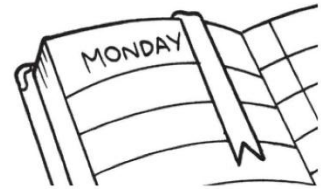

5 Trace and copy

play play

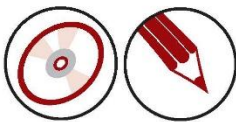

6 Listen and number

 Tuesday

 Friday

 Monday

 Thursday

 Wednesday

 Sunday

 Saturday

Date: _____

UNIT

1



7 Read and match

star
stop
stand

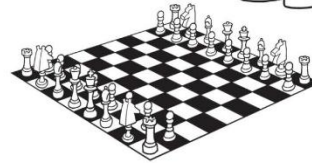
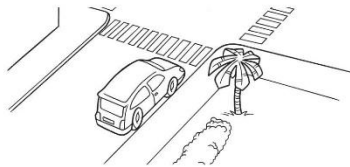

8 Trace and copy

star star



9 Read and match

doll

ball

car

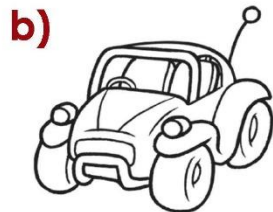
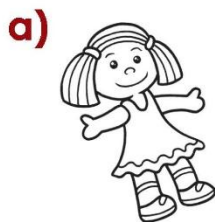



10 Read and match

1)



2)

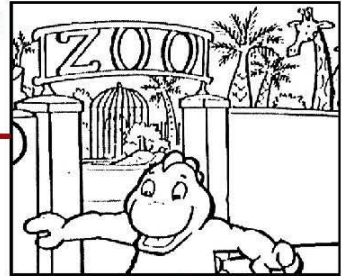

3)

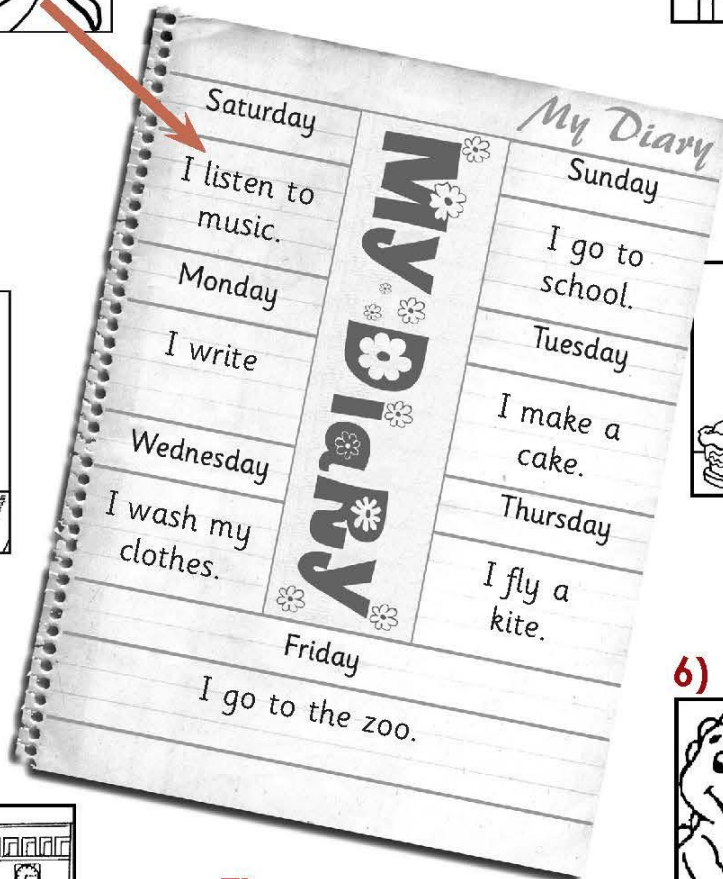

4)



6)



5)

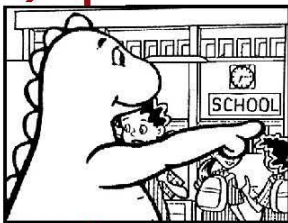

7)

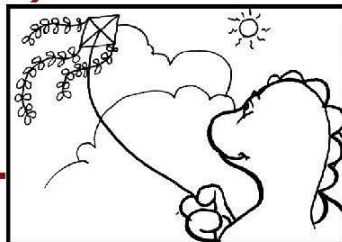

UNIT

2

My House



1 Read and match

1

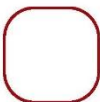

2

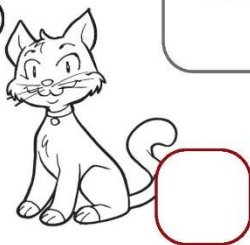

3

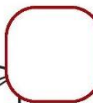
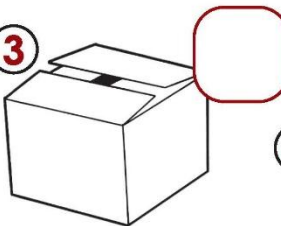

4

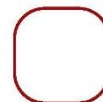
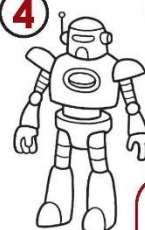
toy
boy

5

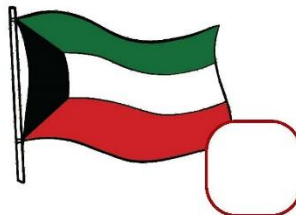

2 Trace and copy

toy toy



3 Listen and number

a)

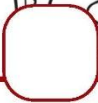

b)



c)

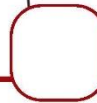

6



4 Read and write

run swim

Can I _____ ?

?

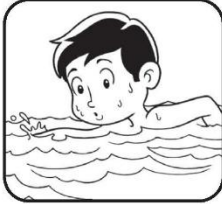

you can.

Can I _____ ?

?



you can't.



5 Read, then complete

①

j _ _ mp



②

m _ _ n



③

b _ _ g



④

l _ _ g



⑤

k _ _ ck



⑥

d _ _ ll



Date: _____

UNIT

2



6 Circle the odd one out

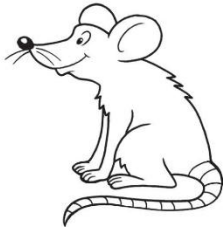
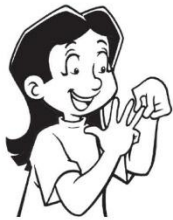

ou

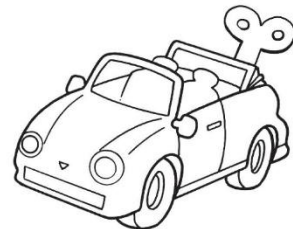
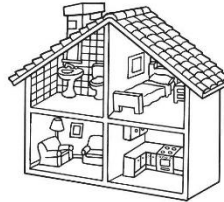

count
mouth
mouse
house



7 Trace and copy

mouse mouse

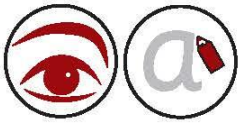

8 Look and write

bedroom living room kitchen bathroom garage

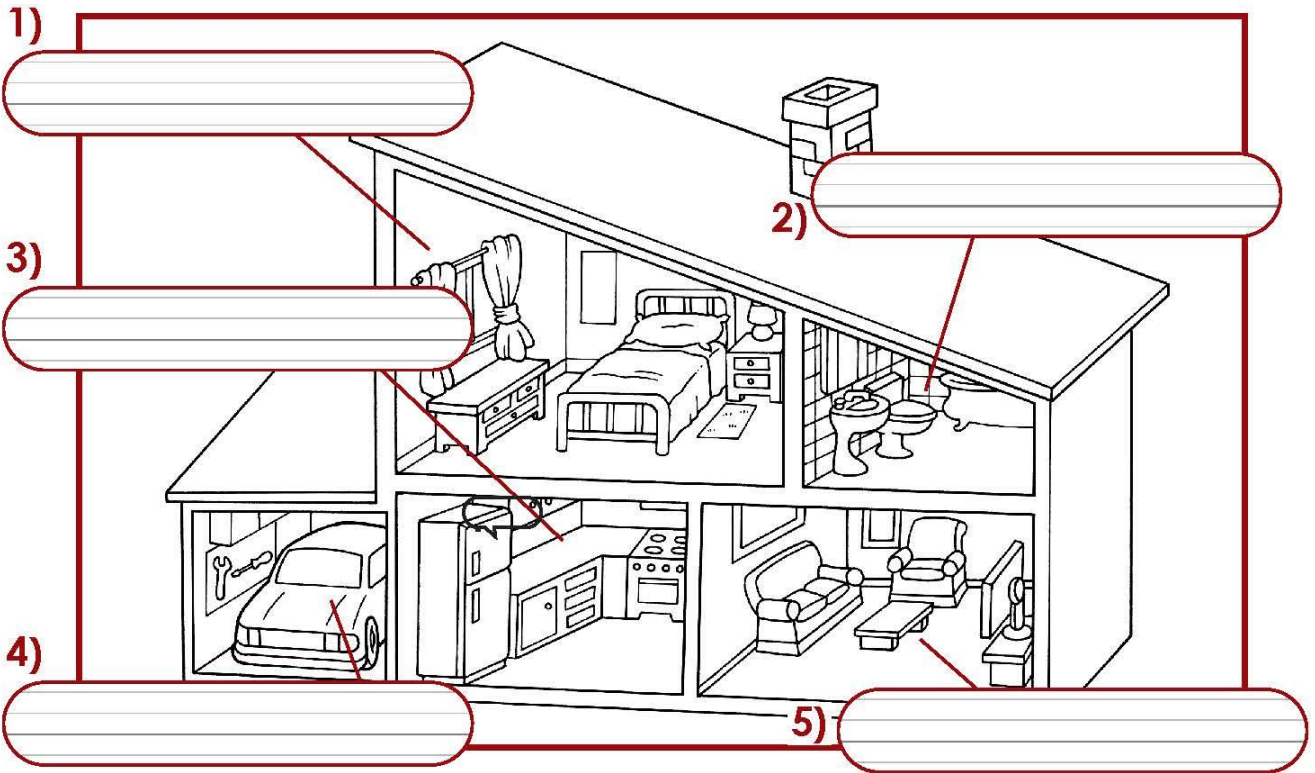

10 Read and write

What are these?

They're _____

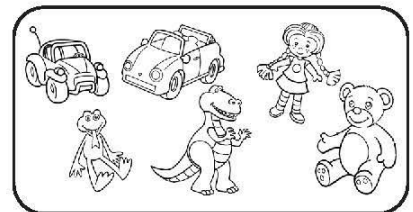

UNIT

3

Let's Find It



1 Read and match



shoes
shirt



2 Trace and match

They're under the chair.

a)

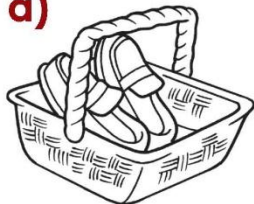

b)

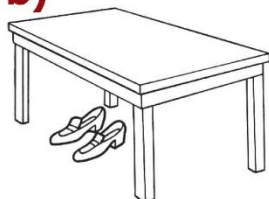

c)

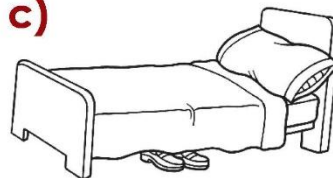

d)



3 Listen and tick

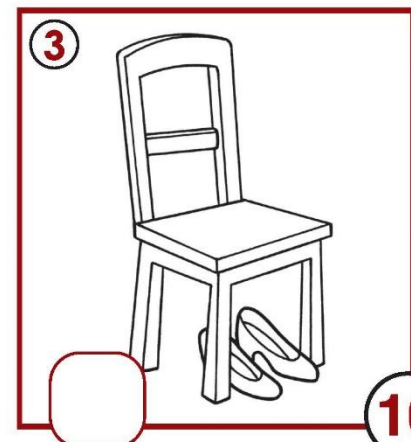
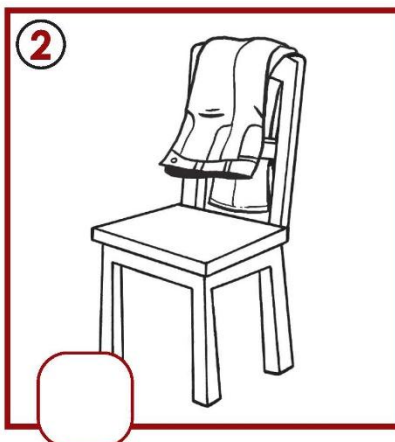
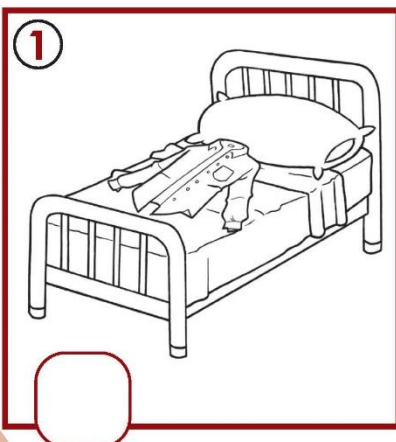

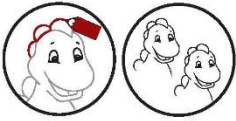

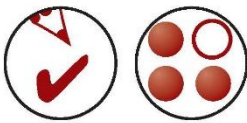

4 Trace and copy

It's on the bed.



5 Tick the odd one out

a) 

b) 

c) 

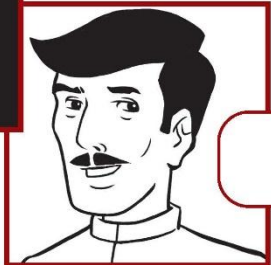
d) 

mother
brother
father

th

Date: _____

UNIT

3



6 Read, then complete

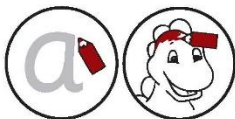
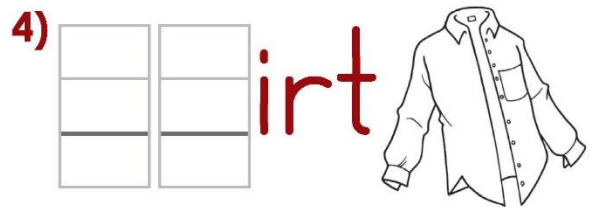
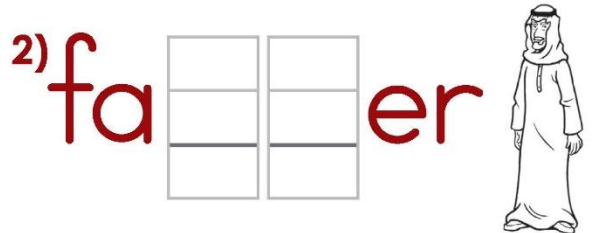
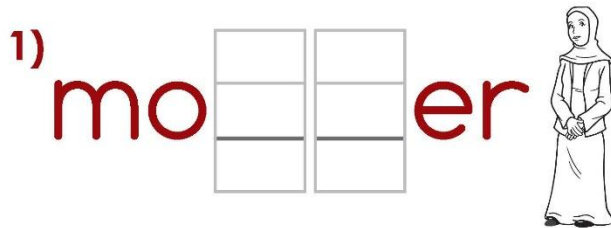

7 Write, colour, then talk about the picture

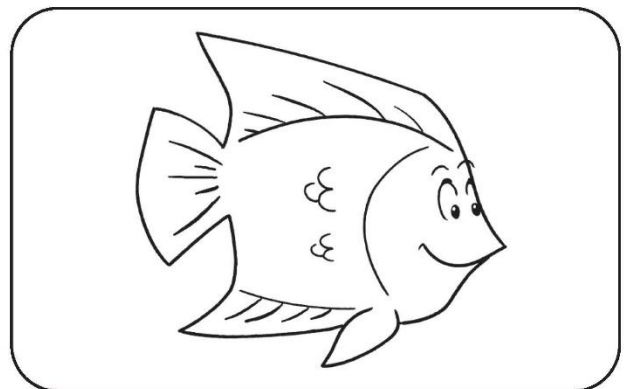



8 Trace, copy and match

There are three pencils.

Blank handwriting lines for copying the sentence.

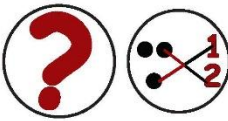
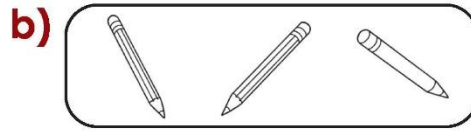
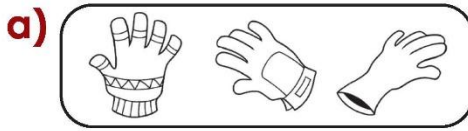

9 Read and match



sh

th



shirt
shoes
Mother
Father



10 Read and match

sheep

three

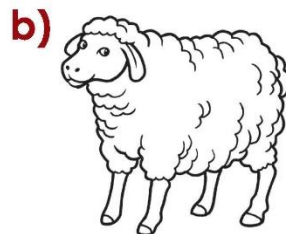

Date: _____

UNIT 3

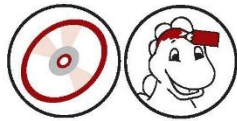

11 Listen and colour

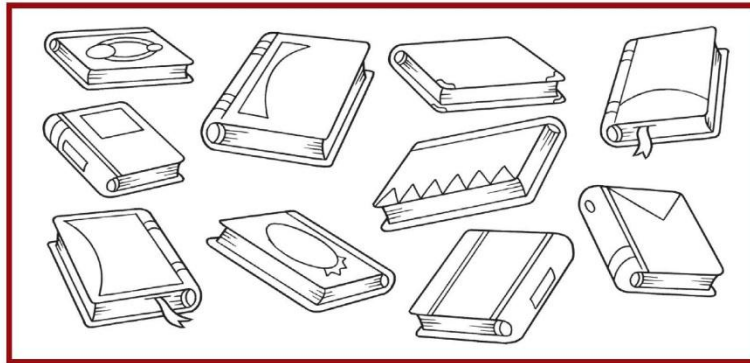

12 Count and write

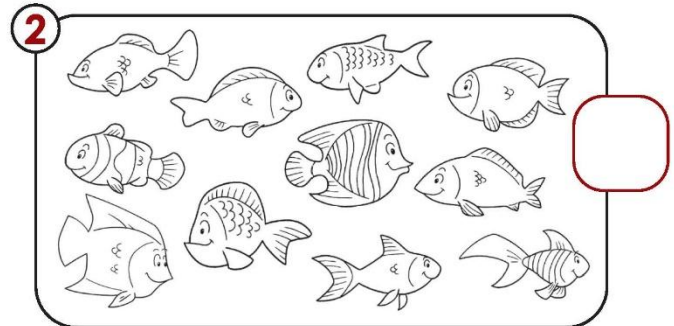
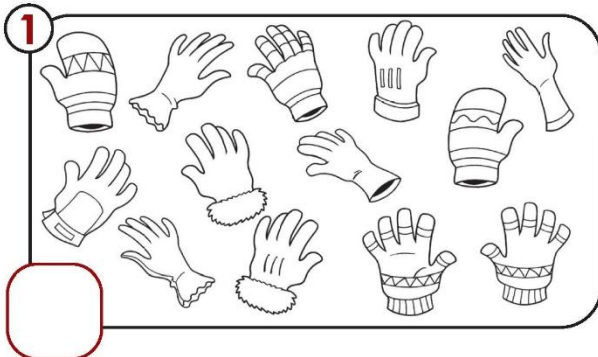

13 Read, then complete

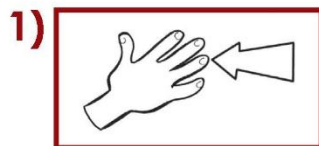

inger

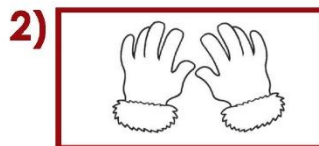

loves

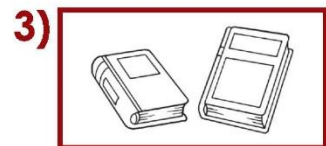

ooks

UNIT **4** Let's Have Fun



1 Read and match



ea

eat
read

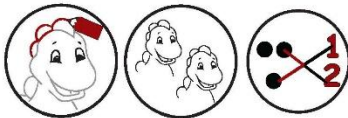

2 Trace, copy and match

I eat ice cream.



3 Read and Complete

1) t

 cher

2) r

 ding

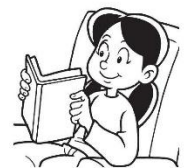

3) ice cr

 m



UNIT 4



4 Read and match

I like running.

I don't like cooking.

a)



b)

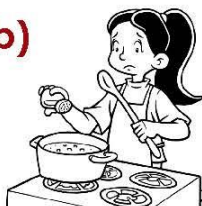

c)

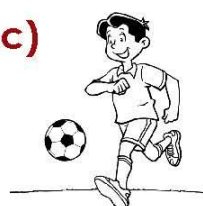

5 Read and copy

Do you like drawing?



Blank lines for copying the text.



6 Listen and number

a)

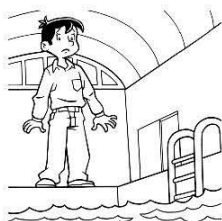

b)



c)



d)





7 Read, complete. then match

① z

② sch

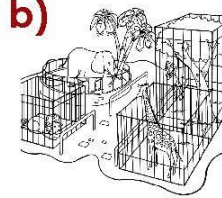
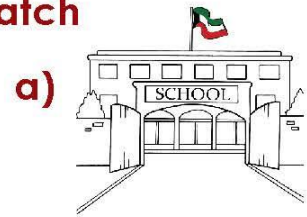

8 Trace, copy and match

I like school.

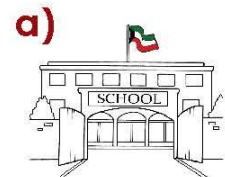

9 Read and colour

Dee likes taking photos.

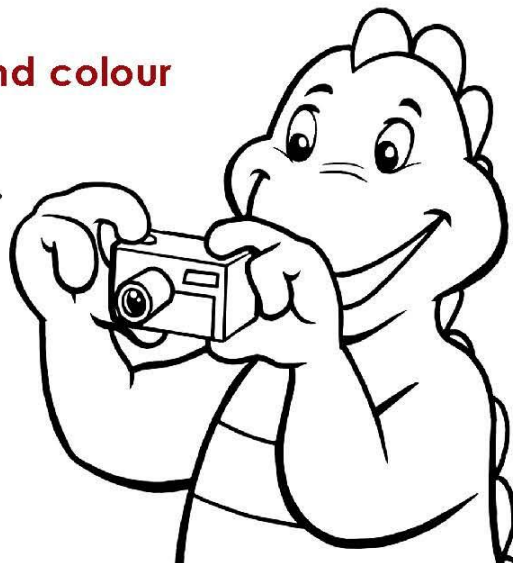

Date: _____

UNIT 4



10 Trace, copy and match

1)

I like painting.

a)



b)



2)

I like roller skating.

c)



11 Read and write

Yes, I do. No, I don't.

Do you like skating?



12 Read and match

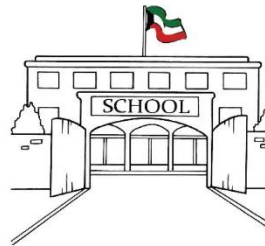
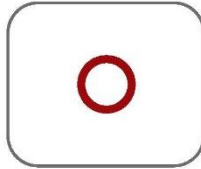
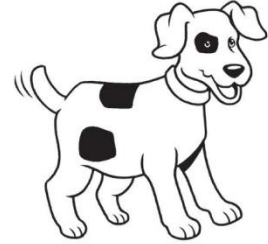
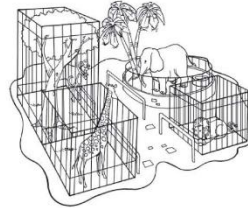
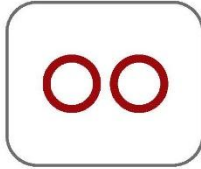
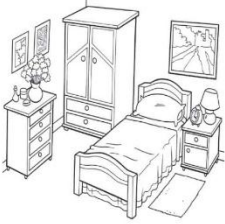

room
hop
doll
zoo
dog
school

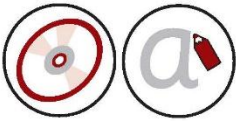

13 Listen and write

① t ② fi ③ z ④ r d



14 Look, read and write



Can we go _____ today?

No, let's go on _____.

At the Restaurant



1. Read, complete and match

① iscuit ② range ③ salad

a)

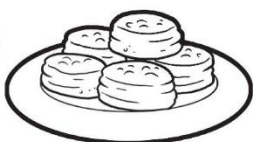

b)



c)

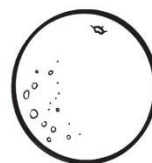

2 Trace, copy and tick

Does Dee eat fish? Yes, he does.

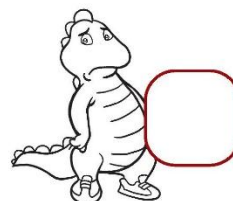
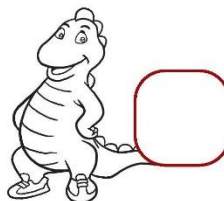
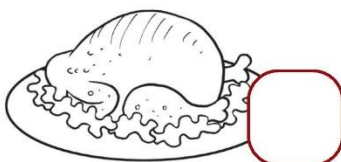

3 Order the sentence

my chicken sandwich That's



4 Order the numbers, then read

3 7 2 11 20 5 4 17 12 6 19 9 10 13 15 14 1 8 16 18



5 Read and classify the words

bread milk ice-skating basketball





6 Read and copy

Do you eat fish?

Date: _____

UNIT

5



7 Read and match

meat

fish

salad

cola

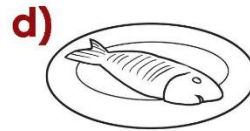

8 Write

Yes, I do - No, I don't

Do you eat

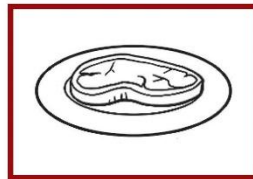

?



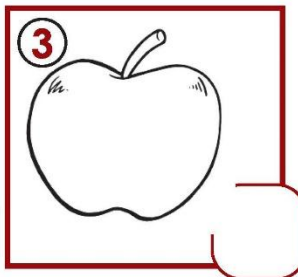
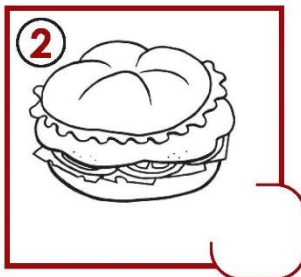
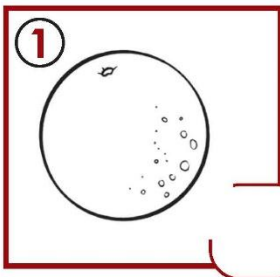

9 Listen and tick

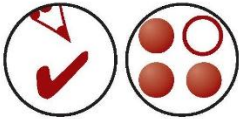

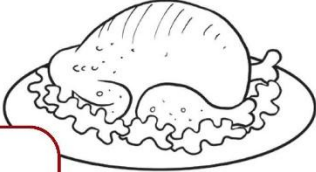
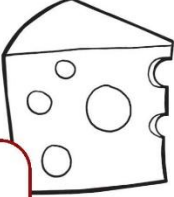

10 Tick the odd one out

 

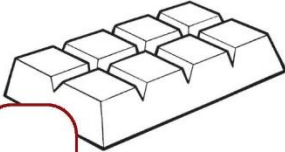
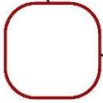

ch

chicken
chese
chocolate
chips

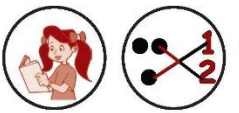

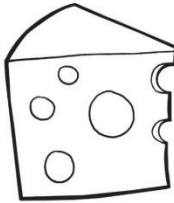
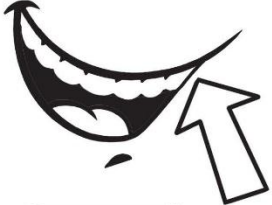
11 Read and match

 

ee

chese
sleep
teeth



12 Read and complete

① Can I have  _____ ?

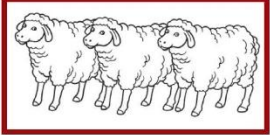
② I can see  _____

Date: _____

UNIT

5



13 Find and match

9

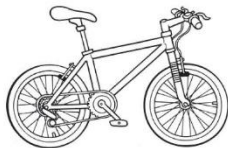

nine
bike
rice



14 Read and complete

hungry thirsty

1

Are you

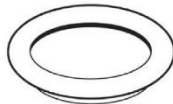

_____ ?

2

Are you



_____ ?

