



State of Kuwait  
Ministry of Education



# **NEW** FUN WITH English



**Activity Book**

Grade

**1B**

 LONGMAN

Julia Allen • Margaret Iggulden



State of Kuwait  
Ministry of Education



# **NEW** FUN WITH **English**

**Activity Book Grade 2A**

**Julia Allen • Margaret Iggulden**

 **LONGMAN**

© Ministry of Education - State of Kuwait. 2009

All rights reserved; no part of this publication may be reproduced, stored in a retrieval system, or transmitted in any form or by any means, electronic, mechanical, photocopying, recording, or otherwise, without the prior written permission of the Publishers.

**Egyptian International Publishing Company - Longman,**

10a Hussein Wassef Street,  
Messaha Square,  
Dokki,  
Cairo,  
Arab Republic of Egypt

The Longman imprint is the property of Pearson Education being used under license from Pearson Education.

First printed in 2003

Reprinted in 2004, 2005, 2006, 2009

Second edition 2020 - 2021 / 2021 - 2022

ISBN: 977 - 16 - 1210 - 7

Deposit No.: 14339 / 2009

Printed in Kuwait by: Printed in Kuwait by : Dar Al- Qabas Press. Printing and Publishing..

### **Acknowledgements:**

Additional material provided by Matthew Hancock

The publisher wishes to thank the Evaluation Committee of Kuwait Ministry of Education:

**Professor Najat Al-Mutawa, Kuwait University;**  
**Professor M. Rifqy Eassa, Educational Holding Group;**  
**Dr. Yusur Al-Madani, Kuwait University;**  
**Mrs. Noha Abdulrazzak Alateegi, College of Basic Education (PAAET);**  
**Mrs. Sakina A. Hussein, Senior Supervisor, MoE;**  
**Mr. Mohamed Nagib Ali, ELT Supervisor, MoE;**  
**Mr. Sayed Ghareeb Abdel Rahman, Supervisor, MoE;**  
**Mr. Alhu Hamu Sharaha, Senior Teacher, MoE;**  
**Mrs. Khawla Al-Refae, Senior Teacher, MoE;**  
**Mr. Mohamed Ibrahim Azatour, Teacher, MoE;**  
**Ms. Aisha Al-Awadhi, Assistant Principal, MoE.**

The publisher also wishes to thank the Amendments Committee of Kuwait Ministry of Education:

**Mrs. Sakina A. Hussein, ELT Supervisor General, MoE;**  
**Mrs. Nouria Al Sedra, ELT Senior Supervisor, MoE;**  
**Mr. Mohamed Nagib Ali, ELT Supervisor, MoE;**  
**Mr. Sayed Ghareeb AbdelRahman, ELT Supervisor, MoE;**  
**Mr. Mahmoud Hammouda, ELT Supervisor, MoE;**  
**Mrs. Khawla Al Refae, ELT Supervisor, MoE;**  
**Mr. Mohamed Sallam, ELT Supervisor, MoE;**  
**Mrs. Sherifah Al Sayegh, ELT Head of Department, MoE;**  
**Mrs. Rehab Mohamed Nadim, ELT Head of Department, MoE;**  
**Mrs. Hessa Al-Banwan, ELT Head of Department, MoE;**  
**Mrs. Noura Al-Mokmash Al-Azmi, ELT Head of Department, MoE;**  
**Mrs. Hana Nasser Al-Hamad, ELT Head of Department, MoE;**  
**Mrs. Azza Mohammad Awad, ELT Head of Department, MoE;**  
**Mrs Nevine Abdul Majeed Omar, ELT Head of Department, MoE.**



PDF Book



Share on evaluation



حضرة صاحب السمو الشيخ نواف الأحمد الجابر الصباح  
أمير دولة الكويت

H.H. Sheikh Nawaf AL-Ahmad Al-Jaber Al-Sabah  
The Amir Of The State Of Kuwait





سمو الشيخ مشعل الأحمد الجابر الصباح

ولي عهد دولة الكويت

H.H. Sheikh Meshal AL-Ahmad Al-Jaber Al-Sabah  
The Crown Prince Of The State Of Kuwait



**Name**

A large, hand-drawn rectangular box with a thick red border, intended for writing a name.

**Age**

A hand-drawn rectangular box with a thick red border, intended for writing an age.

**Grade**

A hand-drawn rectangular box with a thick red border, intended for writing a grade.

**Fingerprint**

A hand-drawn oval box with a thick red border, intended for a fingerprint.





# Contents

---

## Unit 1

### My Day

1	Read and write		
2	Order and colour	Read and match	
3	Read and match	Trace and copy	Listen and number
4	Read and match	Trace and copy	Read and match
5	Read and match		

---

## Unit 2

### My House

6	Read and match	Trace and copy	Listen and number
7	Read and write	Read, then complete	
8	circle the odd one out	Trace and copy	
9	Look and write	Read and write	

---

## Unit 3

### Let's Find It

10	Read and match	Trace and match	Listen and tick
11	Trace and copy	Tick the odd one out	
12	Read, then complete	Write, colour, then talk about the picture	
13	Trace, copy and match	Read and match	Read and match
14	Listen and colour	Count and write	Read, then complete

---





# Contents

---

<b>Unit 4</b> <b>Let's have Fun</b>	15	Read and match	Trace, copy and match	Read and complete
	16	Read and match	Read and copy	Listen and number
	17	Read, complete then match	Trace, copy and match	Read and colour
	18	Trace, copy and match	Read and write	
	19	Read and match	Listen and write	Look, Read and write

---

<b>Unit 5</b> <b>At the Restaurant</b>	20	Read, Complete and match	Trace, copy and tick	Order the sentence
	21	Order the numbers, then read	Read and classfiy the words	Read and copy
	22	Read and match	Write	Listen and tick
	23	Tick odd one out	Read and match	Read and complete
	24	Find and match		Read and complete

---





Date: \_\_\_\_\_

UNIT

1

# My Day



1 Read and write

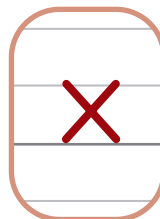
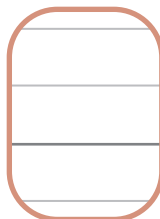
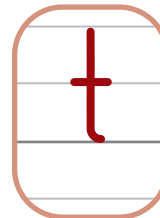
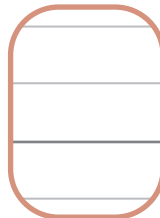
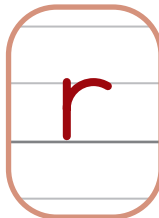
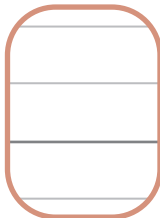
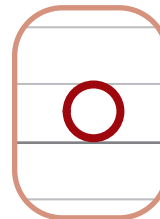
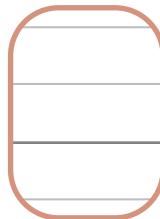
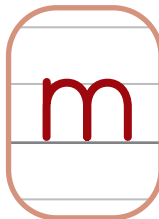
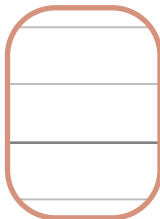
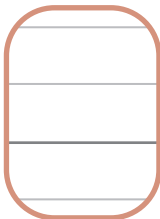
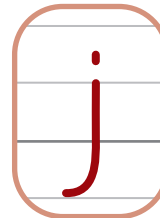
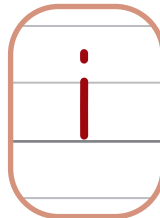
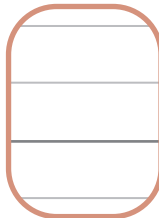
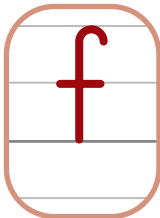
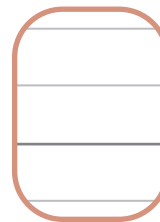
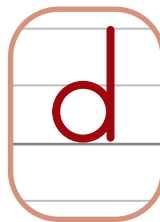
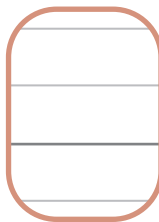
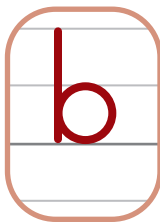

Date: \_\_\_\_\_

UNIT

1



2 Order and colour

a)

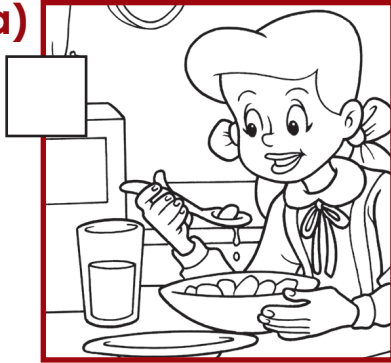

b)

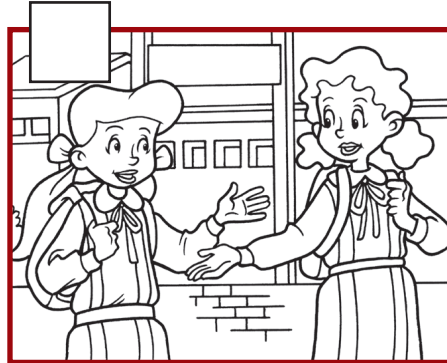

c)

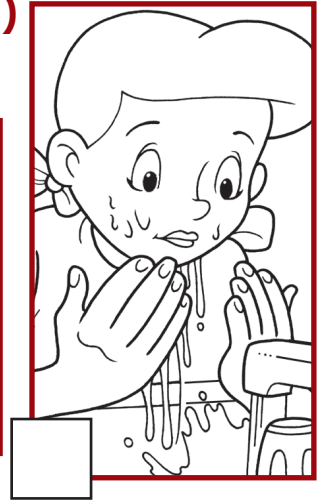

3 Read and match

It's six o'clock.

It's ten o'clock.

a)

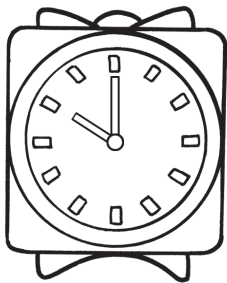

b)

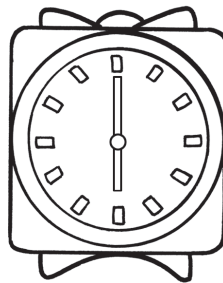

c)

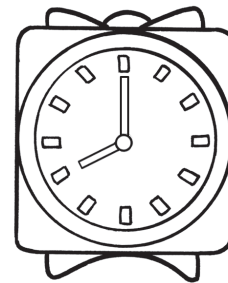



## 4 Read and match



ay



pray  
play  
Monday

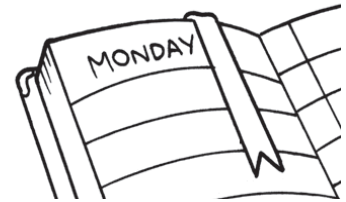

## 5 Trace and copy

play play

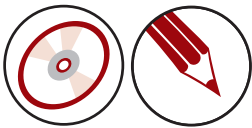

## 6 Listen and number

Tuesday

Friday

Monday

Thursday

Wednesday

Sunday

Saturday

Date: \_\_\_\_\_

# UNIT

# 1



## 7 Read and match

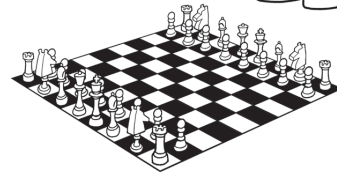
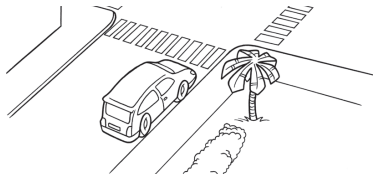
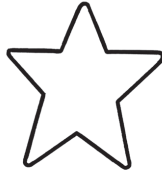

st  
ar  
op  
st  
and



## 8 Trace and copy

star star



## 9 Read and match

doll

ball

car

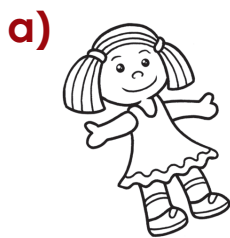



10 Read and match

1)

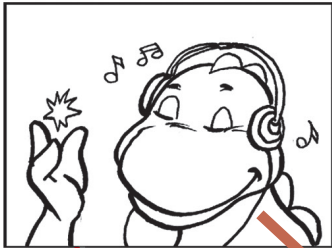

2)

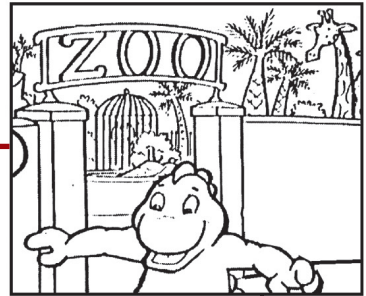

3)



4)



5)

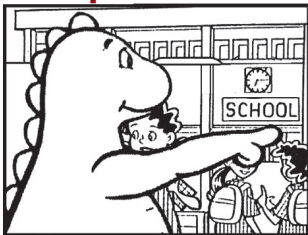

6)



7)





## UNIT

## 2

## My House



1 Read and match

3

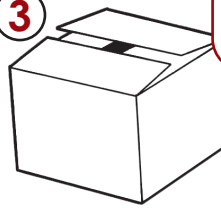
toy  
boy

4

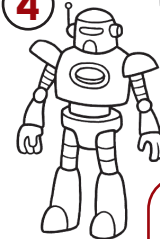

1



2



5

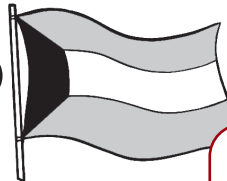

2 Trace and copy

toy toy



3 Listen and number

a)



b)



c)





## 4 Read and write

run swim

Can I \_\_\_\_\_ ?

?

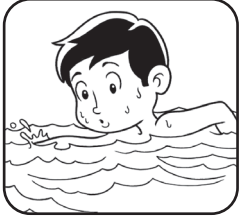

you can.

Can I \_\_\_\_\_ ?

?



you can't.



## 5 Read, then complete

①

j \_ \_ mp



②

m \_ \_ n



③

b \_ \_ g



④

l \_ \_ g



⑤

k \_ \_ ck



⑥

d \_ \_ ll



Date: \_\_\_\_\_

# UNIT 2

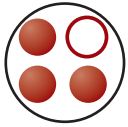

6 Circle the odd one out

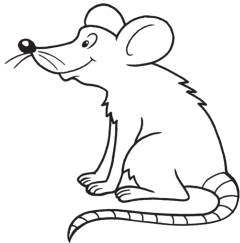

ou

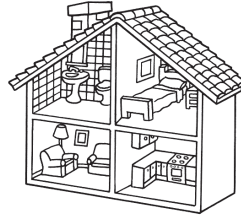

count  
mouth  
mouse  
house

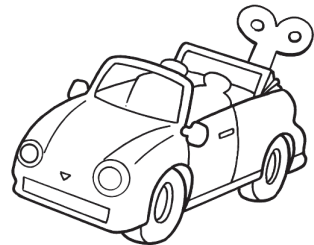

7 Trace and copy

mouse

mouse

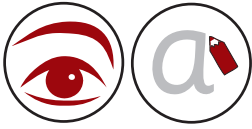

**8 Look and write**

bedroom    living room    kitchen    bathroom    garage

1) 

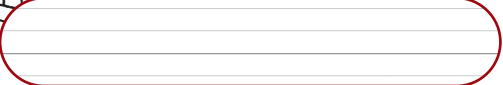
2) 

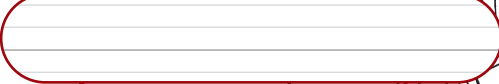
3) 

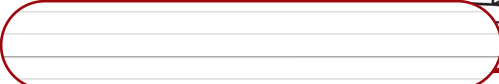
4) 

5) 

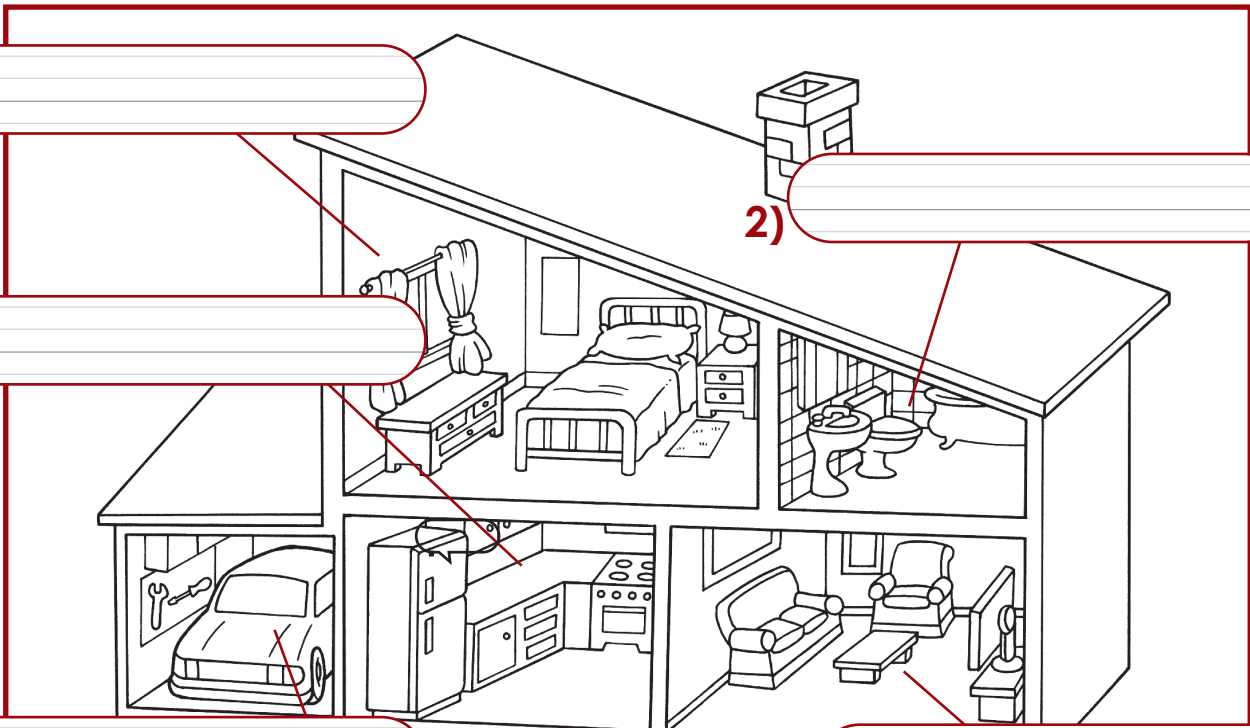

**10 Read and write**

What are these?

They're \_\_\_\_\_

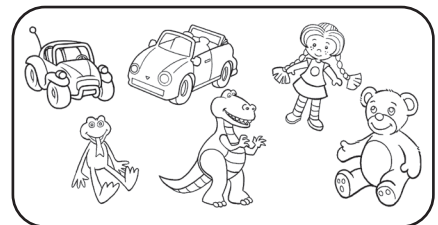

## Let's Find It

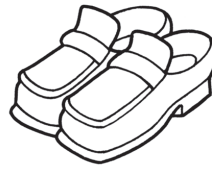

1 Read and match

shoes  
shirt

2 Trace and match

They're under the chair.

a)

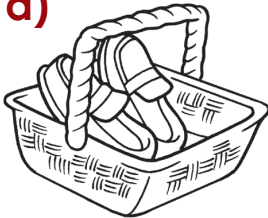

b)

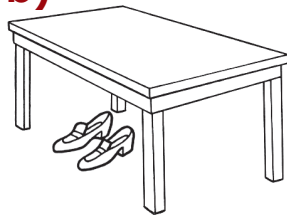

c)

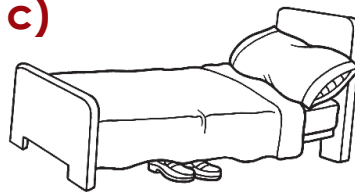

d)

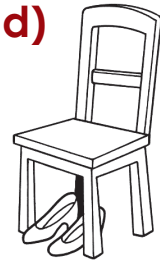

3 Listen and tick

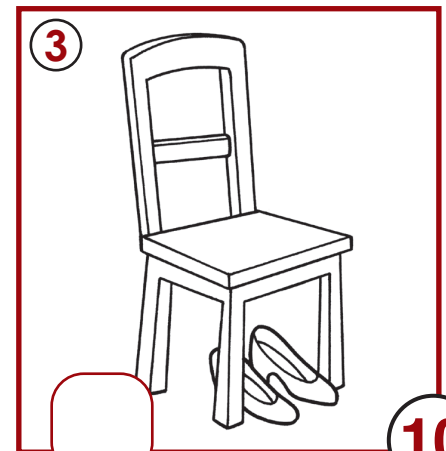
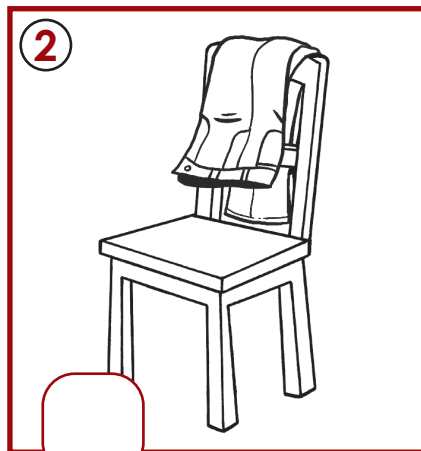
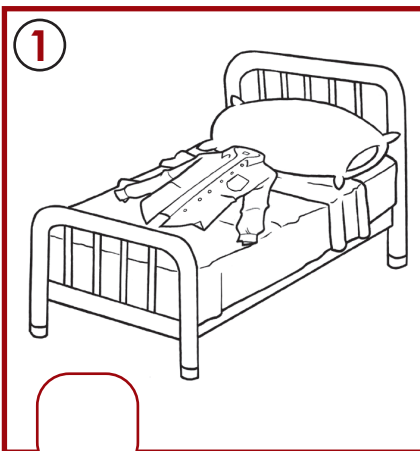



4 Trace and copy

It's on the bed.

Blank handwriting lines for copying the text.

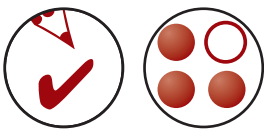

5 Tick the odd one out

a)  b)

c)  mother  
brother  
father d)

th

Date: \_\_\_\_\_

UNIT  
**3**



6 Read, then complete

1)

mo 

 er



2)

fa 

 er



3)

 oes



4)

 irt

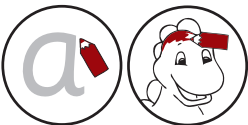

7 Write, colour, then talk about the picture

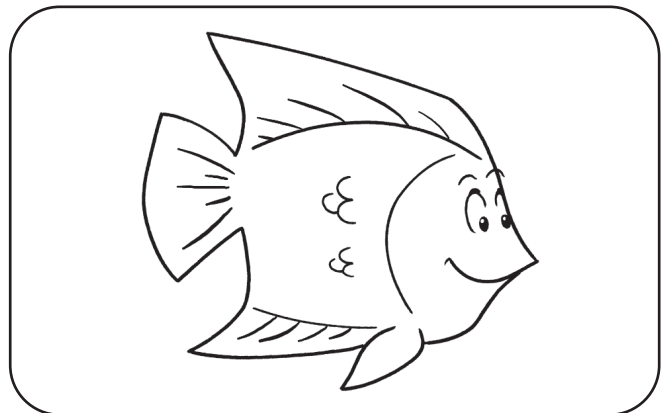





8 Trace, copy and match

There are three pencils.

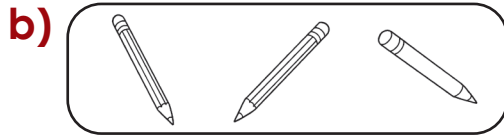
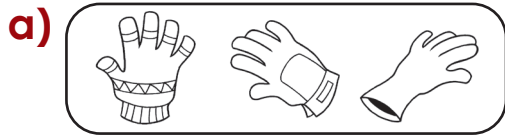
Blank handwriting lines for copying the sentence.



9 Read and match



sh

th

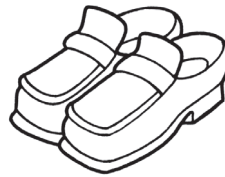

shirt  
shoes  
Mother  
Father



10 Read and match

sheep

three

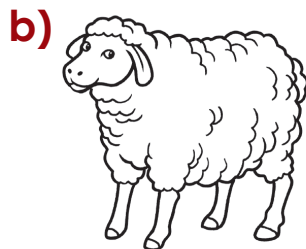



# UNIT 3

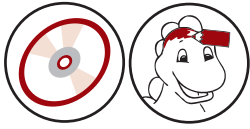

## 11 Listen and colour

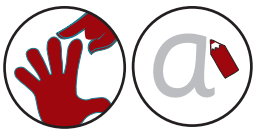
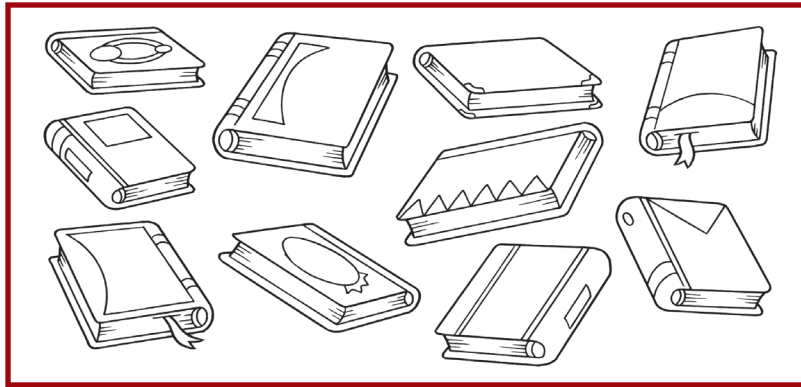

## 12 Count and write

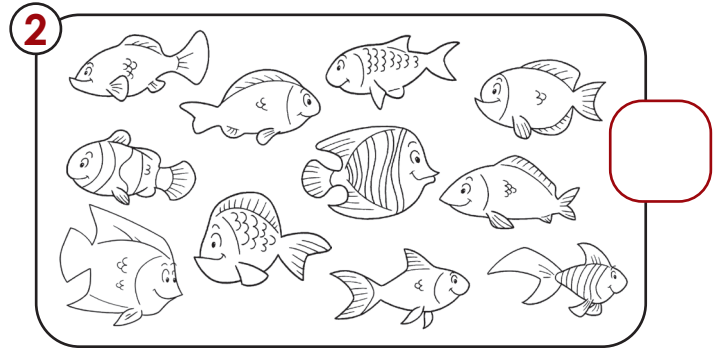
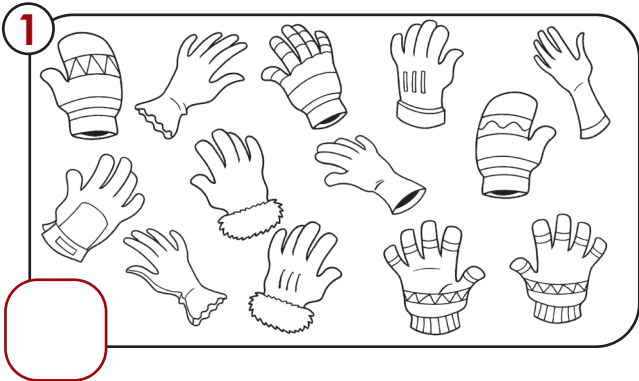

## 13 Read, then complete

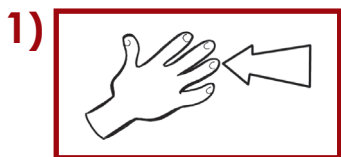

\_\_\_\_\_  
\_\_\_\_\_  
\_\_\_\_\_

inger

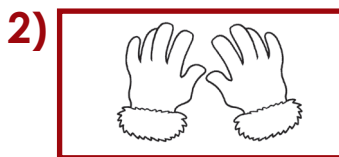

\_\_\_\_\_  
\_\_\_\_\_  
\_\_\_\_\_

loves

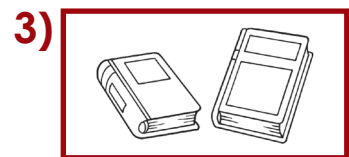

\_\_\_\_\_  
\_\_\_\_\_  
\_\_\_\_\_

ooks

# Let's Have Fun

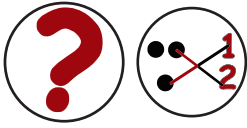

1 Read and match

eat  
read

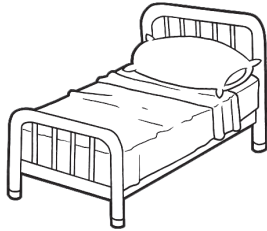

ea



2 Trace, copy and match

I eat ice cream.

\_\_\_\_\_

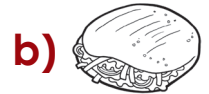

3 Read and Complete

1) t \_\_\_\_\_ cher

2) r \_\_\_\_\_ ding

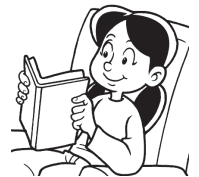

3) ice cr \_\_\_\_\_ m



# UNIT 4



## 4 Read and match

I like running.

I don't like cooking.

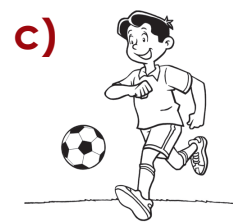
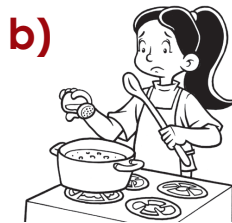
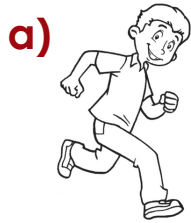

## 5 Read and copy

Do you like drawing?

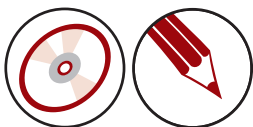

## 6 Listen and number

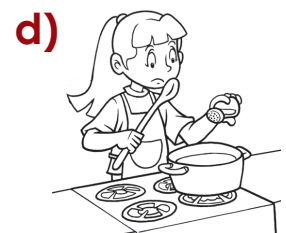
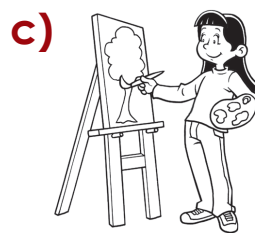
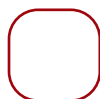
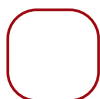
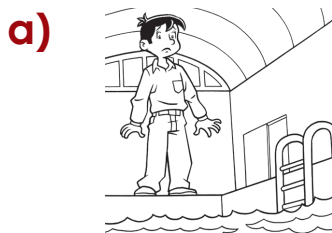



7 Read, complete. then match

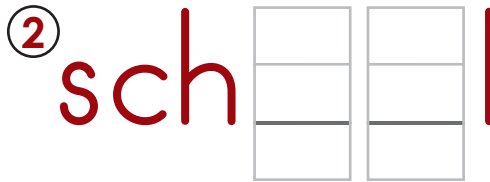

8 Trace, copy and match

I like school.

\_\_\_\_\_



9 Read and colour

Dee likes taking photos.



Date: \_\_\_\_\_

# UNIT 4



10 Trace, copy and match

1) I like painting.

\_\_\_\_\_

\_\_\_\_\_

2) I like roller skating.

\_\_\_\_\_

\_\_\_\_\_

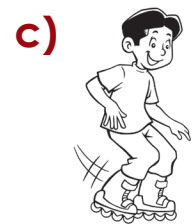
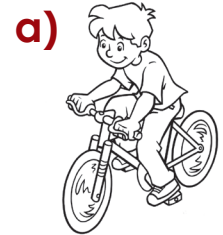

11 Read and write

Yes, I do. No, I don't.

Do you like skating?

\_\_\_\_\_

\_\_\_\_\_



## 12 Read and match

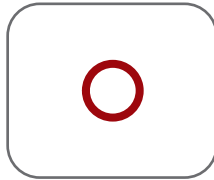
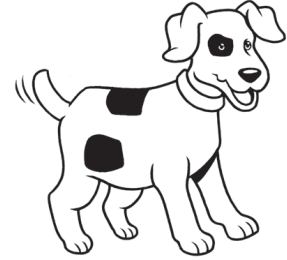
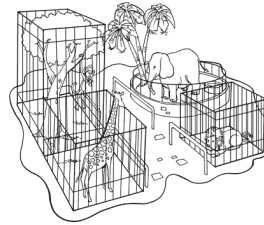

room  
hop  
doll  
zoo  
dog  
school

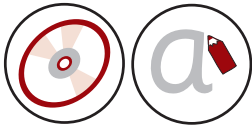

## 13 Listen and write

① t 

 ② fi 

 ③ z 

 ④ r 

 d



## 14 Look, read and write



Can we go \_\_\_\_\_ today?

No, let's go on \_\_\_\_\_.

## UNIT

## 5

## At the Restaurant



1. Read, complete and match

①    iscuit    ②    range    ③    alad

a)

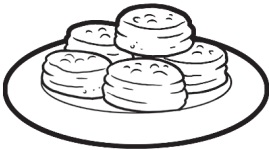

b)



c)

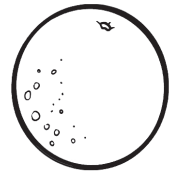

2 Trace, copy and tick

Does Dee eat fish? Yes, he does.

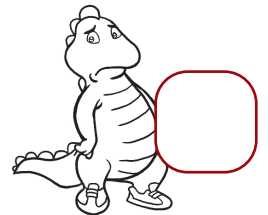
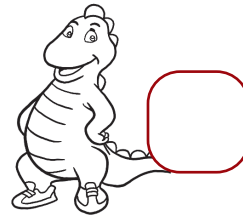
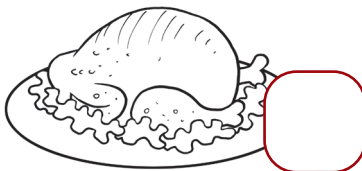
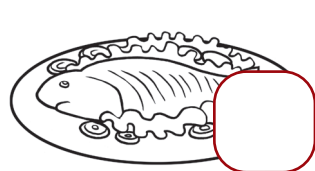

3 Order the sentence

my chicken sandwich That's

\_\_\_\_\_

\_\_\_\_\_

\_\_\_\_\_



**4 Order the numbers, then read**

3 7 2 11 20 5 4 17 12 6 19 9 10 13 15 14 1 8 16 18



**5 Read and classify the words**

bread

milk

ice-skating

basketball





**6 Read and copy**

Do you eat fish?

\_\_\_\_\_

\_\_\_\_\_

\_\_\_\_\_



Date: \_\_\_\_\_

UNIT

5



7 Read and match

meat

fish

salad

cola

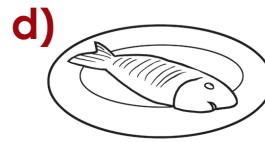

8 Write

Yes, I do - No, I don't

Do you eat



?



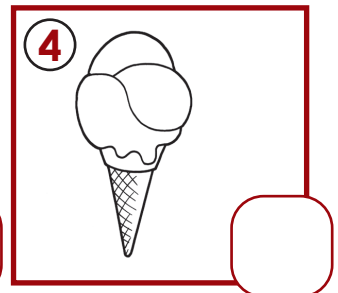
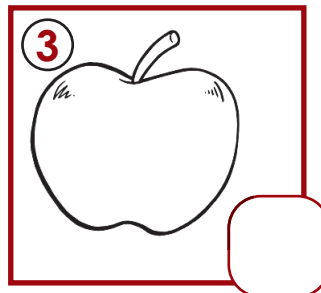
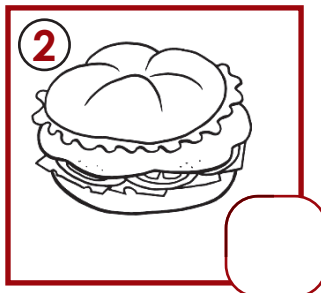
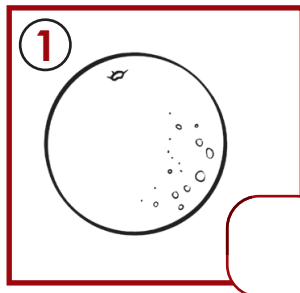

9 Listen and tick

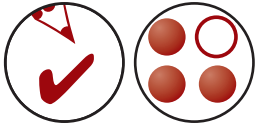

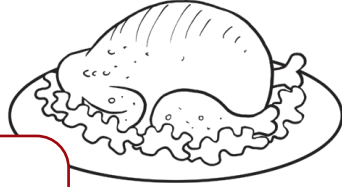
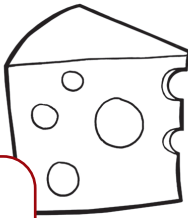

10 Tick the odd one out



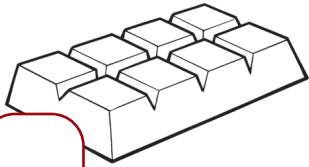
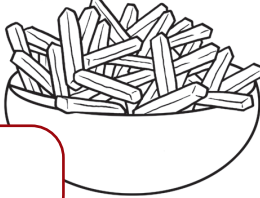

 



chicken  
cheese  
chocolate  
chips

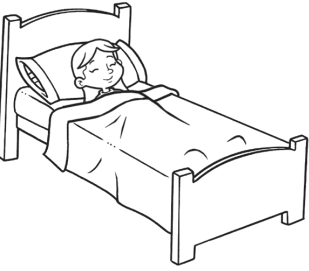

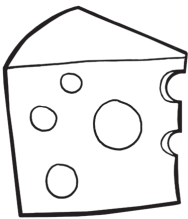
11 Read and match



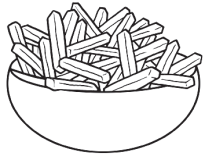



 

cheese  
sleep  
teeth

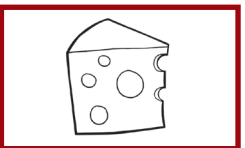

12 Read and complete

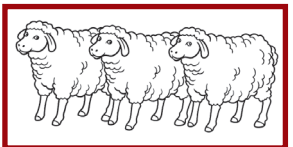
① Can I have  \_\_\_\_\_ ?

② I can see  \_\_\_\_\_

Date: \_\_\_\_\_

UNIT

5



13 Find and match

9

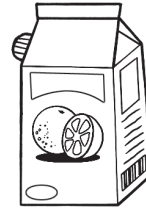
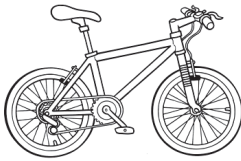

nine  
bike  
rice



14 Read and complete

hungry thirsty

1

Are you



\_\_\_\_\_ ?  
\_\_\_\_\_

2

Are you



\_\_\_\_\_ ?  
\_\_\_\_\_